



ZUBAIR
M E D I C A L

A TRADITION OF QUALITY A PROMISE OF VALUE.

ABOUT US

We Present this Catalogue with the aim of long life commitment and missionary dedication brought the Company, We acquired unblemished of reputation as manufacturers of complete range of Dental Instruments as per standard set by international medical and surgical organizations.

We have come to specialize in instruments concerning Dental Surgery or The two vital factors that can darken or illuminate the world of a patient are the dexterity of the surgeons hands & the precision of the instruments involved. As for as the accuracy of the instruments is concerned, we perform our part as conscientiously as is possible by the combination of human hands and the latest available technology.

Service to humanity comes first on our agenda, business and profit is the second.

From the procurement of raw materials to packing, all the phases of the process are conducted under the same roof. This ensures and facilitates our interference at any stage of the process, which makes it possible for us to achieve perfection. Our technical experts can achieve any degree of technicality, ranging from the slightest variations to complete redesigning and production of entirely new items.

The quality of raw materials is of the international standard, but we can also satisfy individual specifications selecting from a large variety of imported steel.

We also welcome enquires for the instruments not listed in this catalogue both in the Dental Instruments

Plaster Shears
 2-180

2-180-8.00"

Bruns Shears
 2-181

2-181-9 1/2"

Multi-Cut Utility Scissors
 2-182 to 2-184

 2-182-Shears 5.50" all colors
 2-184-Shears 7.25" all colors
 16 Different Colors

Mayo Dissecting Scissors
 2-186 to 2-195

 2-186-5.50" Straight
 2-188-5.50" Curved
 2-190-6.75" Straight
 2-192-6.75" Curved
 2-193-9.00" Straight
 2-195-9.00" Curved

Metzenbaum Scissors

Size 2-194 to 2-200

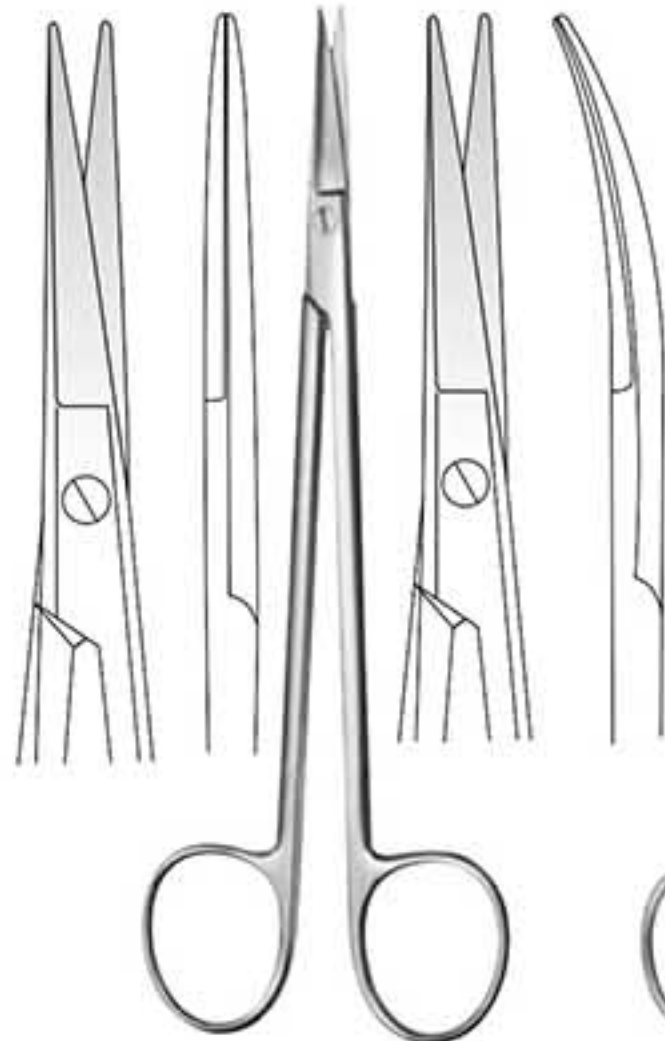
Kelly-Adson Scissors

2-202 to 2-206

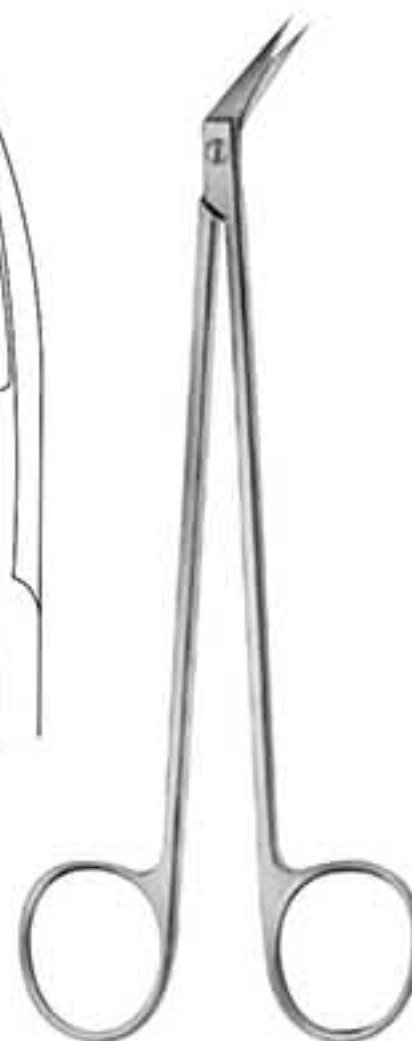
Locklin Scissors

2-207

2-207 - 6.1/2" Curved

Dissecting Scissors

2-208

2-208-4.50"

Knowles Bandage Scissors

2-210

2-210-5.50"

5.50"	2-194-Straight	196-Curved	2-202 - 6.00" Straight
7.00"	2-198-Straight	200-Curved	2-204 - 6.00" Curved
8.00"	2-167-Straight	169-Curved	2-206 - 6.00" Angular
9.00"	2-171-Straight	173-Curved	
11.0"	2-175-Straight	177-Curved	

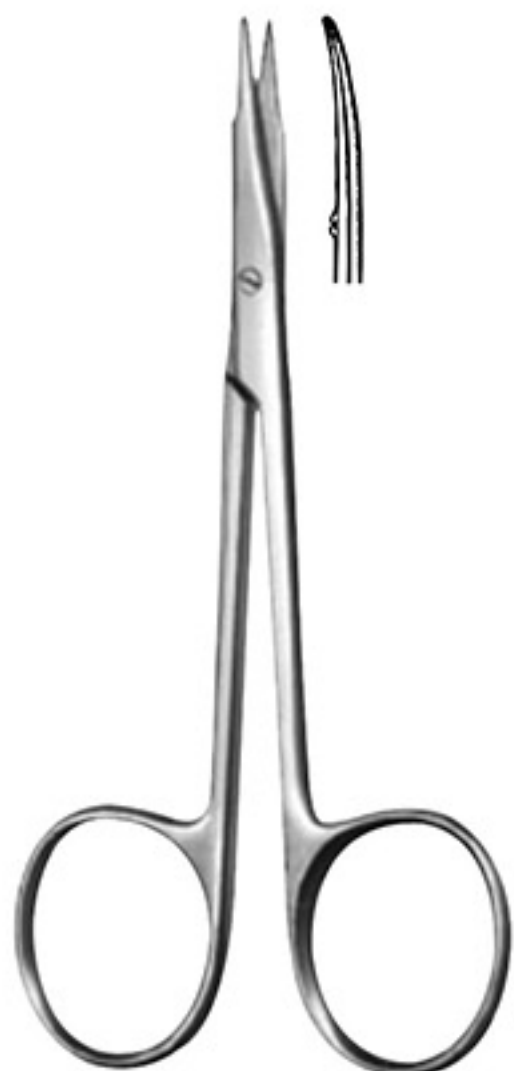

Stevens Tenotomy Scissors
3-212 to 3-214

- 3-212-4.50" Straight S/S
- 3-214-4.50" Curved S/S
- 3-212B-4.5" Straight B/B
- 3-314B-4.5" Curved B/B

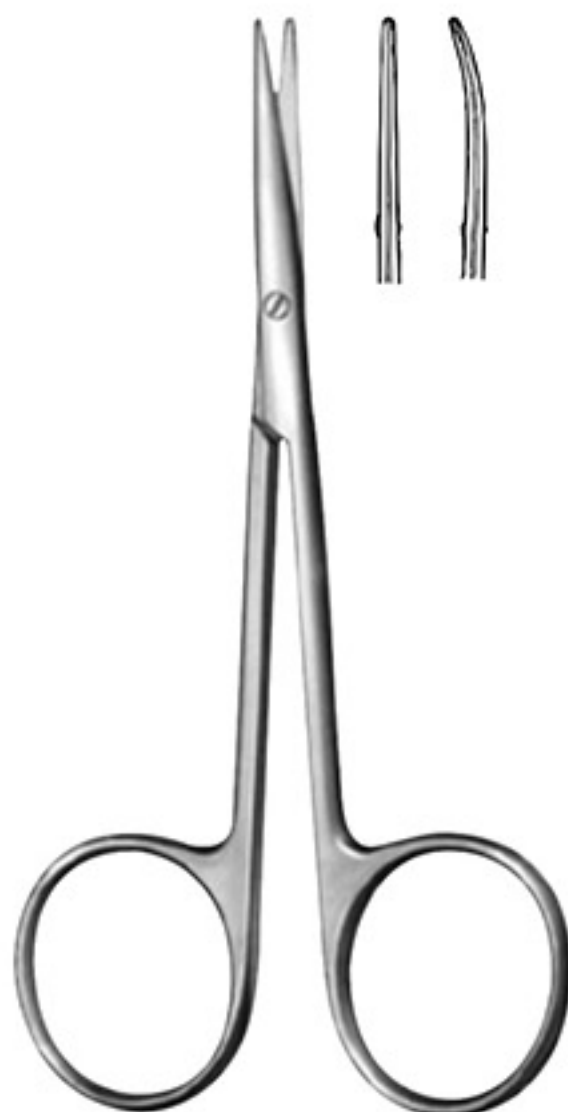

Strabismus Scissors
3-216 to 3-218

- 3-216-4.50" Straight
- 3-218-4.50" Curved



Deaver Scissors Delicate
3-220 to 3-226

- 3-220-5.50" S/B Straight
- 3-222-5.50" S/B Curved
- 3-224-5.50" S/S Straight
- 3-226-5.50" S/S Curved



Wire Cutting Scissors
3-228 to 3-230

- 3-228-4.50" Straight
- 3-230-4.50" Curved



Wire Cutting Scissors Angular
3-232

- 3-232-4.75"



Umbilical Scissors
3-234

- 3-234-4.00"



Mayo-Noble Dissecting Scissors
3-235 to 3-236

- 3-235 - 6.50" Straight
- 3-236 - 6.50" Curved



Doyen Scissors
3-237 to 3-238

- 3-237-7.00" Straight
- 3-238-7.00" Curved



Sims Scissors
4-239 to 4-240

4-239-8.00" Straight
4-240-8.00" Curved



Dorsal-Angular

Foman Scissors
4-241 to 4-242

4-241 - 5.25" Lower Lateral Cvd.
4-242 - 5.25" Dorsal Angular

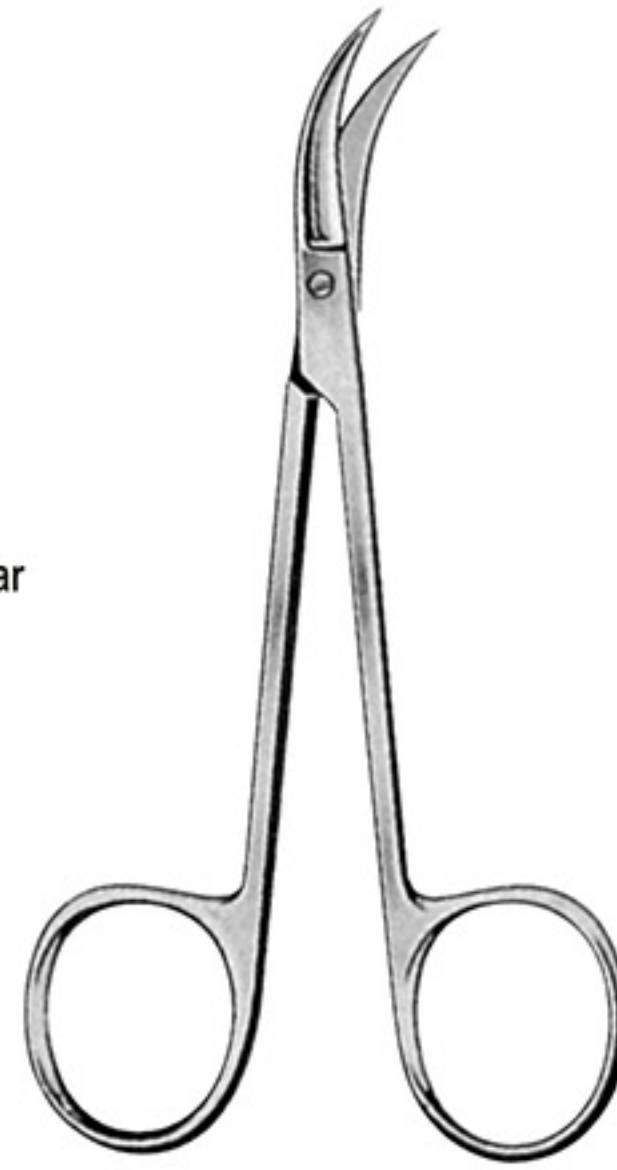

Hill Scissors
4-243

4-243-4.75"



Knight Nasal Scissors
4-244

4-244-6.25"



La Grange Scissors
4-245

4-245-4.50" Sharpe/Sharpe



Suture North Bent Scissors
4-246 to 4-247

4-246-3.50"
4-247-4.75"



Heath Scissors
4-248

4-248-6.25"

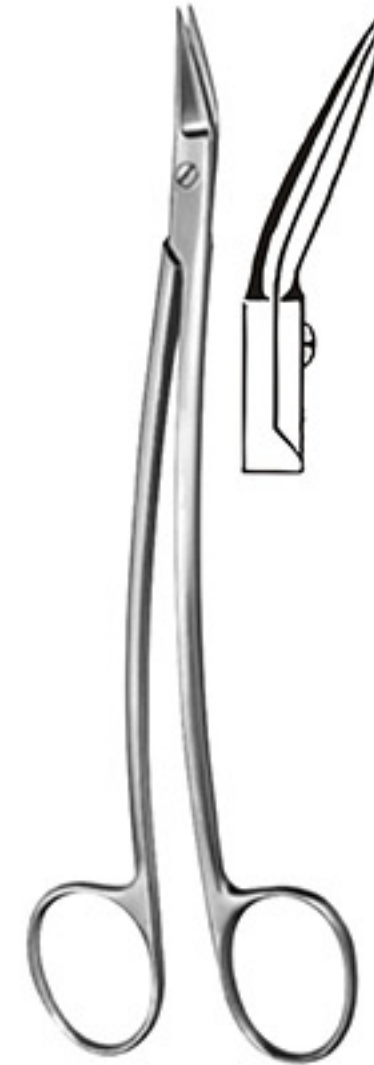

Dean Scissors
4-249

4-249-7.25"



Burnham Finger Bandage Scissors
4-250 to 4-251

4-250-5.50"
4-251-8.50"



U.S. Pattern Gauze Scissors
5-253

5-253-8.00"

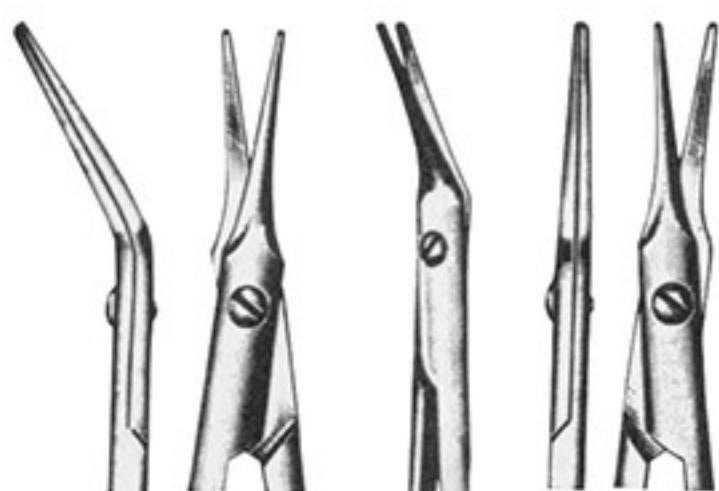

Aebli Corneal Scissors
5-268 Str. 5-270 Cvd.

5-268 Str.
5-270 Cvd.



Plastic Handle Bandage Scissors
274

5-274-5 1/2"
"12 Colors Available"



Nursing Scissors Same Ring
5-275

5-275-5 1/2"



Castroviejo Scissors
5-260 to 5-261

5-260-3.50"
5-261-4.00"



Jacobson Spring Handle Scissors
5-262 to 5-267

5-262 - 5.25" Straight 5-265 - 6.25" Curved
5-263 - 5.25" Curved 5-266 - 7.00" Bayonet
5-264 - 6.25" Straight 5-267 - 7.00" Bayonet



Vannas Spring Handle Scissors
5-254 to 5-255

5-254-3.00" Straight
5-255-3.00" Curved



McClure Spring Handle Scissors
5-256 to 5-258

5-256-4.25" Straight
5-257-4.25" Angled
5-258-4.25" Curved



Westcott Tenotomy Scissors
5-259

5-259-4.50"
Curved



Castroviejo Olsen Heager
5-259A-5-259B

5-259A-5 1/2"
5-259B-6"

Mayo-Hegar Needle Holder

6-302 to 6-311

6-302-5.00"	6-308- 7.00"
6-304-5.50"	6-309- 8.00"
6-306-6.00"	6-310-10.00"
	6-311-12.00"

Baumgartner Needle Holder

6-312 to 6-314

6-312-5.00"
6-314-5.50"

Derf Needle Holder

6-316

6-316-4.75"

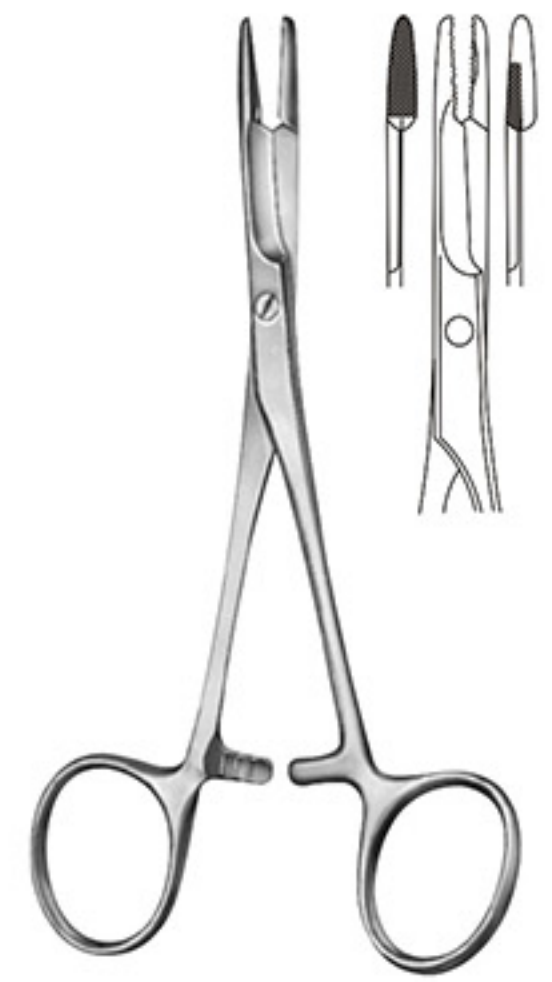
Olsen-Hegar Needle Holder

6-318 to 6-322

6-318-5.50"
6-320-6.50"
6-322-7.50"

Collier Needle Holder

6-324

6-324-5.00"

Crile-Wood Needle Holder

6-326

6-326-6.00"
6-325-7.00"
6-327-8.00"
6-329-9.00"

Webster Needle Holder

6-328 to 6-334

6-328-4.50"
6-330-4.75"
6-332-5.00"
6-334-6.00" Halsey N.H.Satin

Mathieu Needle Holder

6-335 to 6-338

6-335-5.50"
6-336-6.50"
6-338-7.50"



Abbey Needle Holder
7-340

7-340-5.00"



Johnson Needle Holder
7-342

7-342-10.75"



Crile-Murray Needle Holder
7-344

7-344-6.00"



Brown Needle Holder
7-346

7-346-5.25"



Halsey Needle Holder
7-348 to 7-350

7-348-5.00" Smooth
7-350-5.00" Serrated



Castroviejo Needle Holder
7-352

7-352 - 5.50"



Barraquer Needle Holder
7-354

7-354 - 4.50"



Stangel-Barraquer Needle Holder
7-356

7-356 - 4.50"



Jacobson Micro Needle Holder
7-358 to 7-360

7-358 - 7.00"
7-360 - 8.50"



Jacobson Micro Needle Holder
7-362

7-362 - 7.00"
Straight W/Lock

A TRADITION OF QUALITY A PROMISE OF VALUE.

Roch-Pean Forceps
 8-402 to 8-423

8-402 - 5.50"	Straight	8-414 - 8.00"	Straight
8-404 - 5.50"	Curved	8-416 - 8.00"	Curved
8-406 - 6.25"	Straight	8-418 - 9.00"	Straight
8-408 - 6.25"	Curved	8-420 - 9.00"	Curved
8-410 - 7.00"	Straight	8-421 - 12.0"	Straight
8-412 - 7.00"	Curved	8-423 - 12.0"	Curved

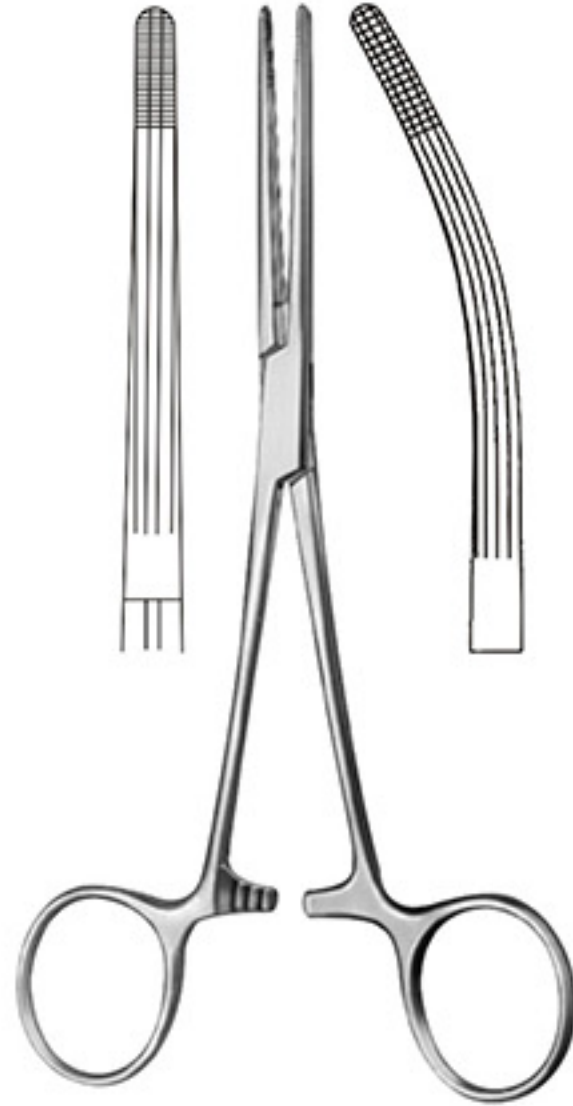
Roch-Carmalt Forceps
 8-422 to 8-428

8-422 - 6.25"	Straight
8-424 - 6.25"	Curved
8-426 - 8.00"	Straight
8-428 - 8.00"	Curved

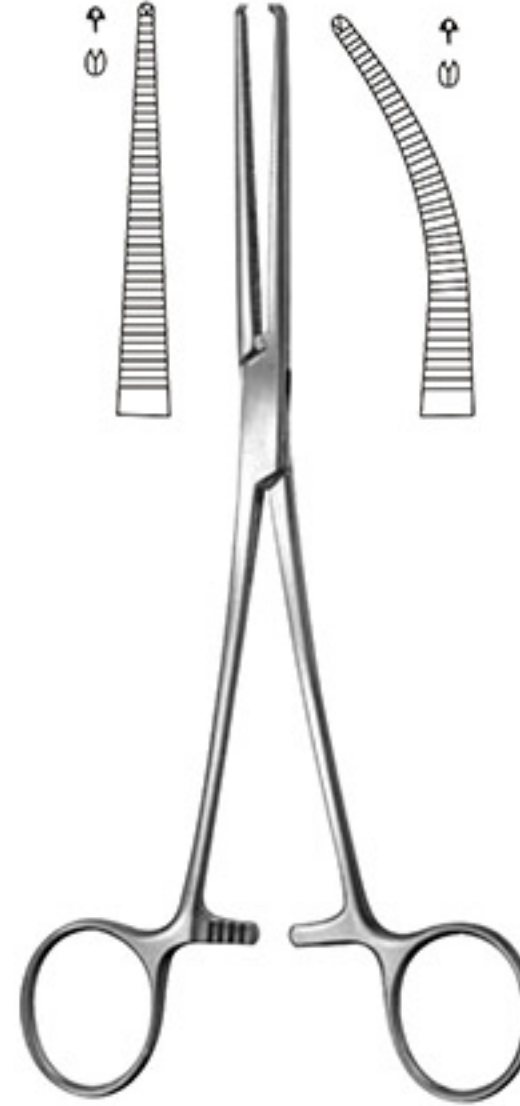
Mosquito Koucher Forceps
 8-430 to 8-432

8-430 - 5.00"	Straight
8-432 - 5.00"	Curved

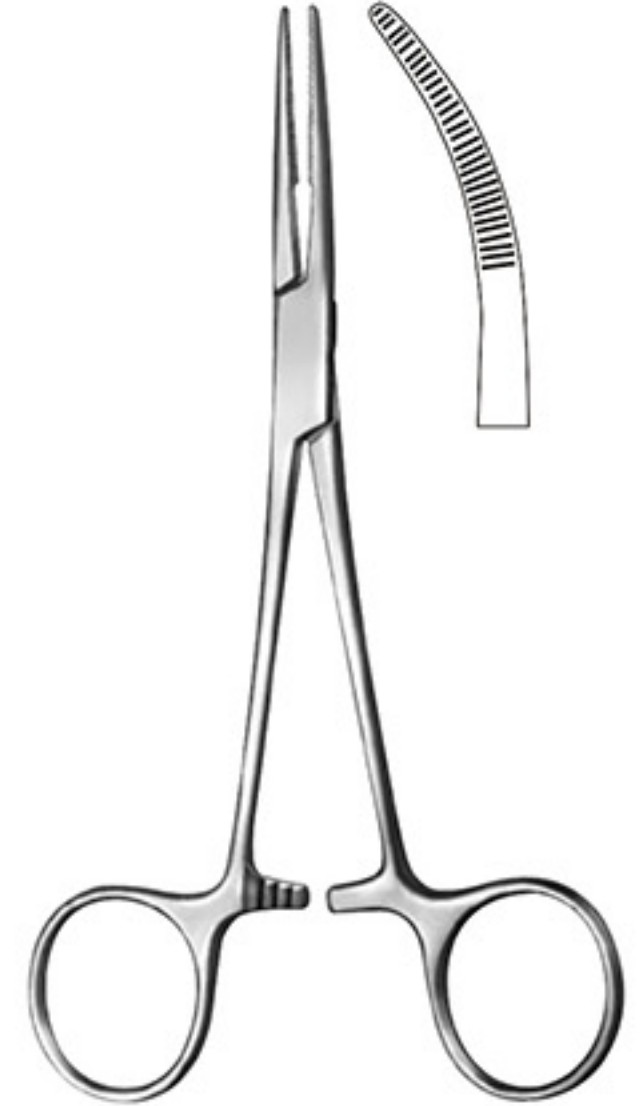
Kelly/Rankin Forceps
 8-434 to 8-440

8-434 - 5.50"	Straight
8-436 - 5.50"	Curved
8-438 - 6.25"	Straight
8-440 - 6.25"	Curved

Crile Forceps
 8-442 to 8-448

8-442 - 5.50"	Straight	8-446 - 6.25"	Straight
8-444 - 5.50"	Curved	8-448 - 6.25"	Curved

Providence Hospital Forceps
 8-450 to 8-452

8-450 - 5.50"	Straight
8-452 - 5.50"	Curved

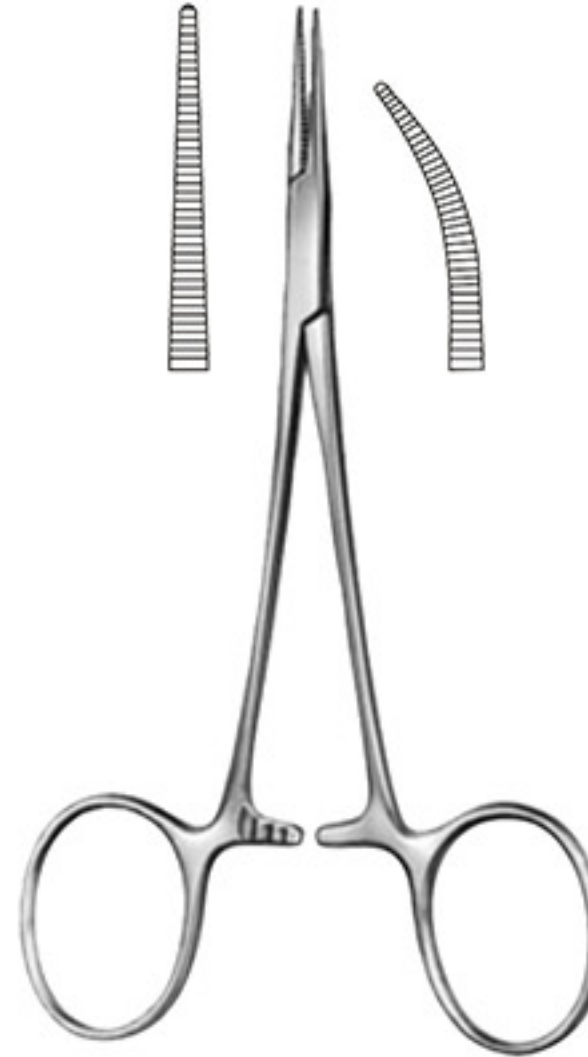
Halsted Mosquito Forceps
 8-454 to 8-459

8-454 - 4.00"	Straight Hartman Mosquito Forceps
8-455 - 4.00"	Curved Hartman Mosquito Forceps
8-456 - 5.00"	Straight Halsted Mosquito Forceps
8-457 - 5.00"	Curved Halsted Mosquito Forceps

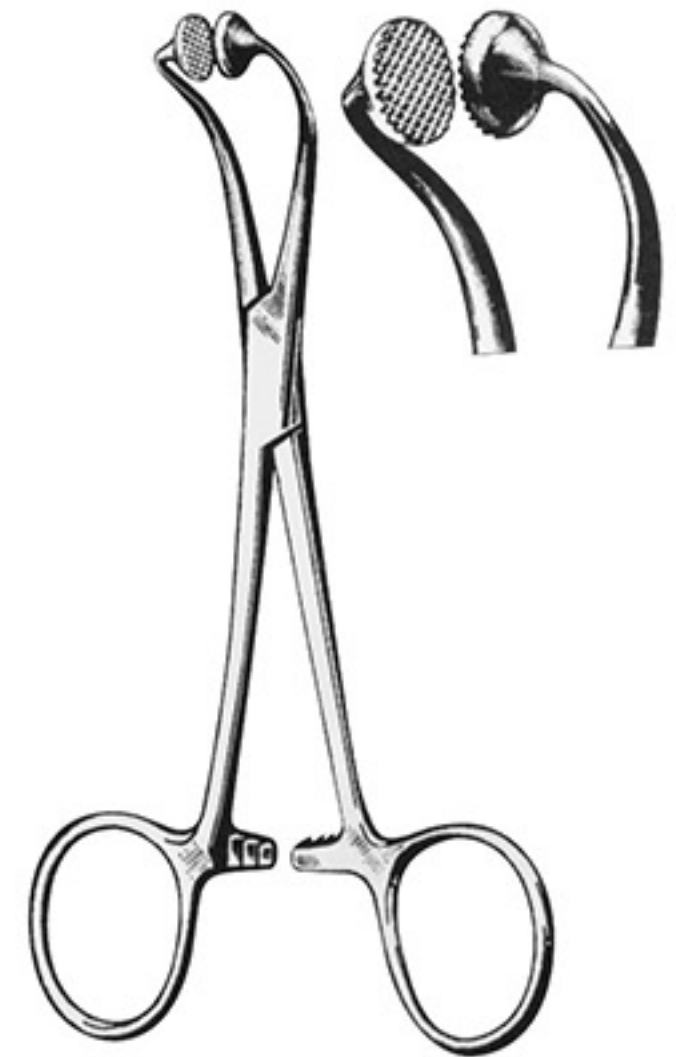
Hoff Towel Clamp
 8-461 to 8-463

8-461 - 4.00"
8-463 - 5.25"



Backhaus Towel Clamps	Roeder Towel Clamps	Ball and Socket	Lorna (Edan) Towel Clamp	Magill Catheter Forceps
9-462 to 9-464	9-466	9-467 to 9-469	9-468 to 9-470	9-472 to 9-476
9-462-3.25" 9-464-5.25"	9-466-5.25"	9-467-4.1/4" 9-469-5.1/4"	9-468-4.25" 9-470-5.25"	9-472- 6.00" 9-474- 8.00" 9-476-10.00"



Sterilizer Forceps	Roch-Ochsner Forceps	Billroth Forceps	Schroder Tenaculum Forceps	Duplay Tenaculum Forceps
9-478 to 9-480	9-481 to 9-492	9-493	9-494	9-495
9-478-8.00" 3 Prongs 9-480-11.0" 3 Prongs	9-481-5.50" Straight 9-483-5.50" Curved 9-482-6.25" Straight 9-484-6.25" Curved	9-486-7.25" Straight 9-488-7.25" Curved 9-490-8.00" Straight 9-492-8.00" Curved	9-493-4x4 teeth 9-494-9.00"	9-496-11.00"



Pennington Grasping Forceps
10-497

10-497-6.00"



Duval Grasping Forceps
With 1" wide jaw

8.00"



Babcock Forceps
10-496 to 10-499

10-496- 6.25"
10-498- 8.25"
10-499-10.00"



Tube Occluding Clamps
10-500 to 10-502

10-501-5.00"
10-500-6.25"
10-502-7.25"



Vorse Tube Clamp Serrated
10-503

10-503-7.25" Serrated



Tube Occluding Clamp W/ Guard
10-504

10-504-7.25"



Iowa Membrane Forceps
10-505

10-505-10.00"



Allis Tissue Forceps
10-506 to 10-509

10-506- 6.00" 4x5 Teeth
10-507- 6.00" 5x6 Teeth
10-508- 7.00" 5x6 Teeth
10-509- 10.00" 5X6 Teeth



Young Tongue Seizing Forceps
11-507

Collins Tongue Seizing Forceps
11-509

Bozeman Forceps
11-526 to 11-528

Mayo-Robson Forceps

Bozeman Sponge Forceps
11-530 to 11-531

11-507-6.25" W/Rubber

11-509-6.50" (Collins)

11-526-10.00" Straight
11-528-10.00" Curved

11-527-9.00" Straight
11-529-9.00" Curved

11-530-10.00" Straight
with one large ring
11-531-10.00" Curved
with one large ring



Foerster Sponge Forceps
11-532 to 11-543

Schröder Vulsellum Forceps
11-544

Teale Vulsellum Forceps
11-546

Adson Forceps
11-547 to 11-548

Mixer Forceps
11-549 to 11-551

11-532-7.00" Serrated Straight
11-534-7.00" Serrated Curved
11-536-7.00" Smooth Straight
11-537-7.00" Smooth Curved
11-538-9.50" Serrated Straight
11-540-9.50" Serrated Curved
11-542-9.50" Smooth Straight
11-543-9.50" Smooth Curved

11-544-9.50" Straight

11-546-9.00" 3x4 Teeth

11-547-7.25" Straight
11-548-7.25" Curved

11-549-5.50"
11-550-7.25"
11-551-9.50"

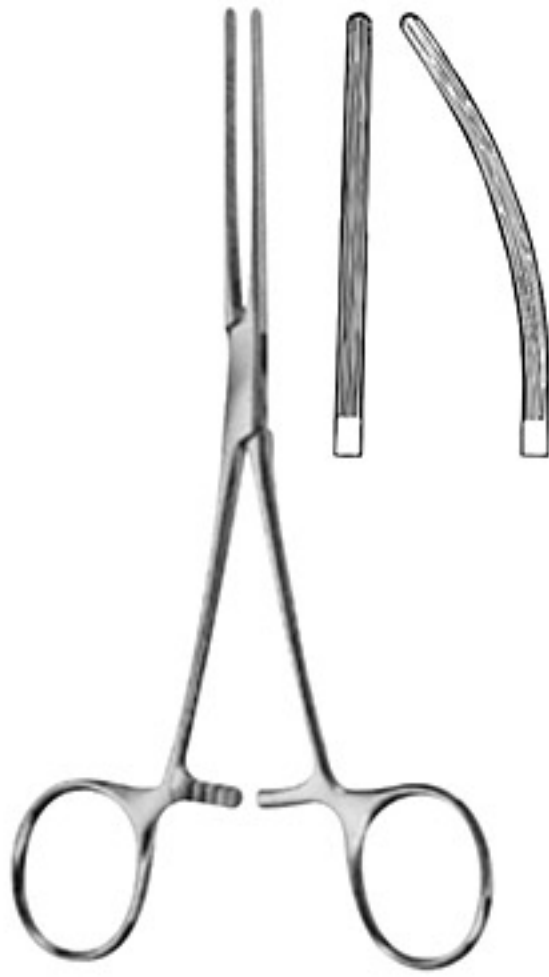

Doyen Forceps
 W/Longitudinal Teeth
 12-552 to 12-553

12-552-9.00" Straight
 12-553-9.00" Curved

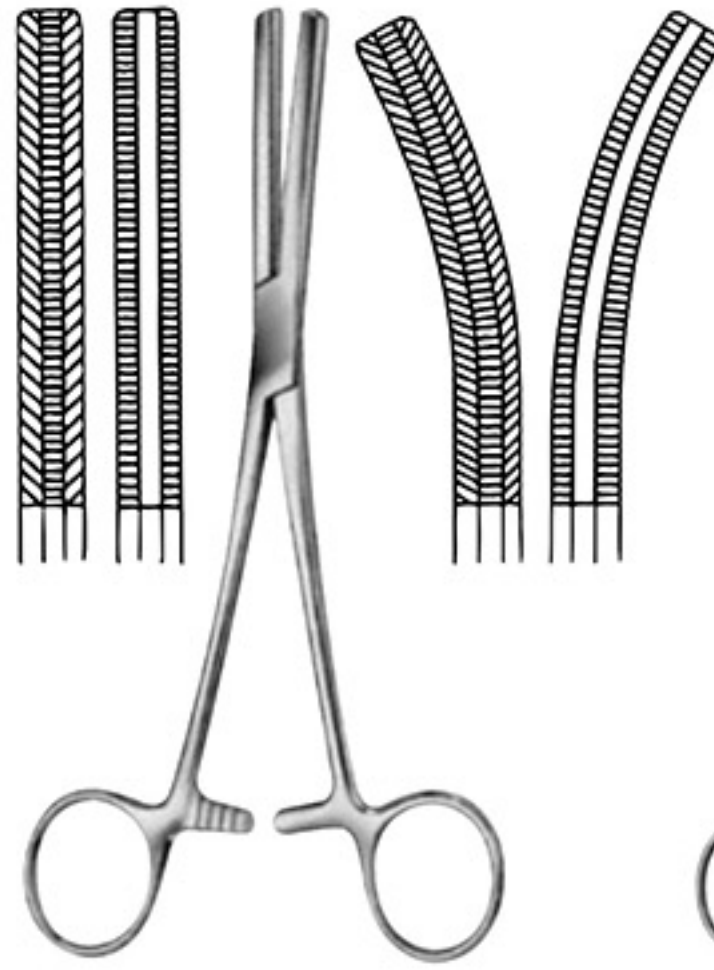

Ferguson Forceps
 12-554 to 12-560

12-554-6.00" Straight
 12-556-6.00" Curved
 12-558-7.00" Straight
 12-560-7.00" Curved



Doyen Clamp
 W/Cross Serrated Teeth
 12-565 A-B

12-565 A -9.00" Straight
 12-565 B -9.00" Curved

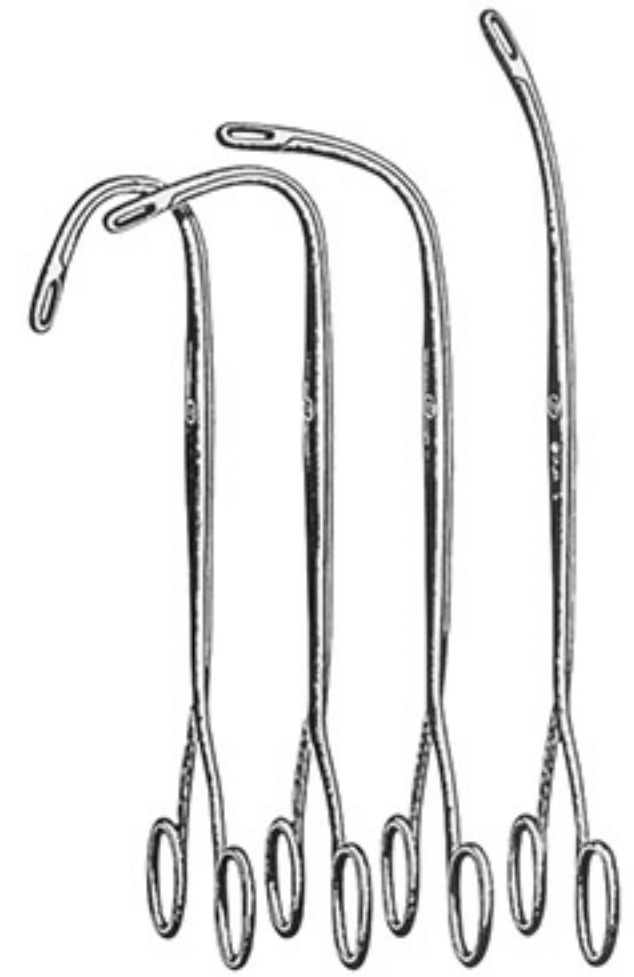

Kidney Stone Forceps
 12-566 to 12-569

12-566-9.25" (Quarter) Curved
 12-567-8.50" (Half) Curved
 12-568-7.75" (3Quarter) Curved
 12-569-7.75" (Full) Curved



Blake Gallstone Forceps
 12-570 to 12-571

12-570-8.25" Straight
 12-571-8.25" Curved



Mayo-Blake Gallstone Forceps
 12-572 to 12-573

12-572-8.00" Straight
 12-573-8.00" Curved

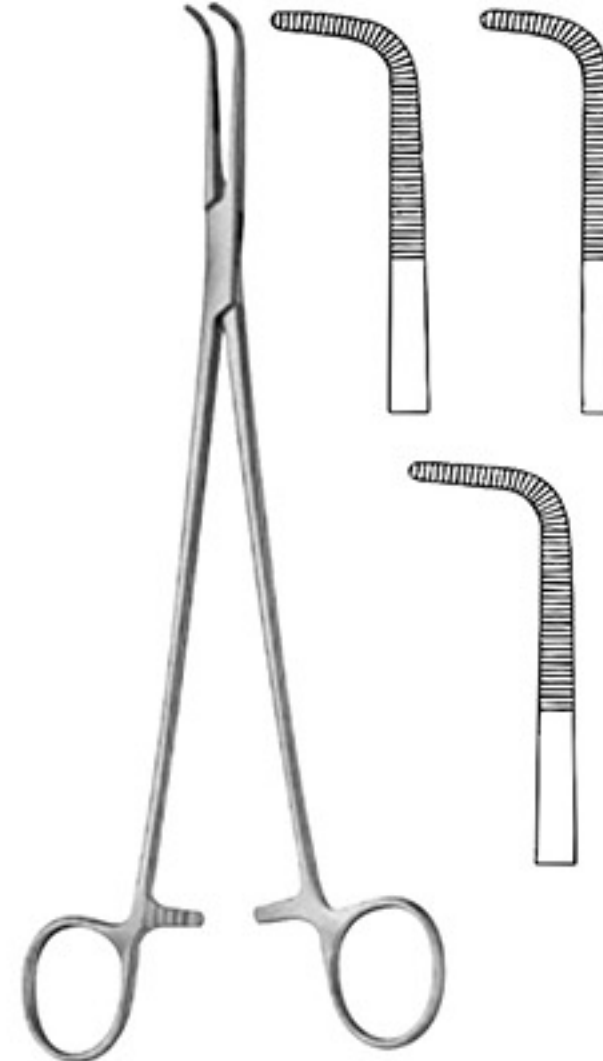

Kantrowitz Thoracic Clamp
 12-574 to 12-576

12-574- 7.50"
 12-575- 9.50"
 12-576-10.50"



Payr Pylorus Clamp
 12-577 to 12-580

12-577- 5.75"
 12-578- 8.00"
 12-579-11.00"
 12-580-13.00"



Wertheim-Cullen Pedicle Clamp
13-581

13-581-7.50"



Benson Pylorus Separator
13-582

13-582-5.75"

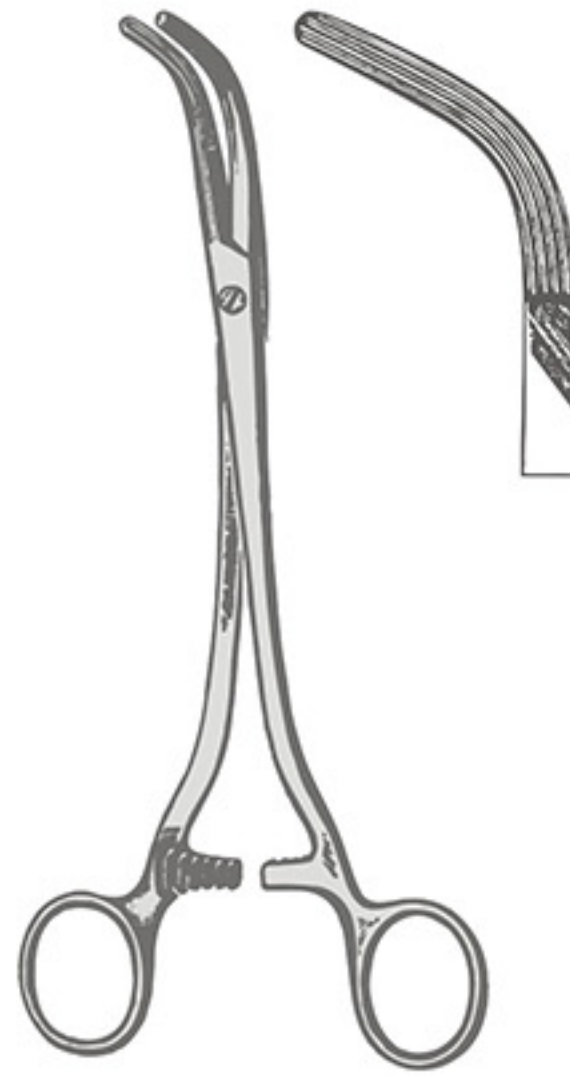

Crile Gall Duct Forceps
13-583

13-583-8.00"



John Hopkins Gall Bladder Forceps
13-584

13-584-8.00"



Thoracic Clamp
13-585 to 13-586

13-585- 8.00" Curved
13-586-10.00" Curved



Semb Dissecting Forceps
13-587

13-587-9.50"



Jacobs Vulsellum Forceps
13-588 to 13-589

13-588-8.25" Straight
13-589-8.25" Angular

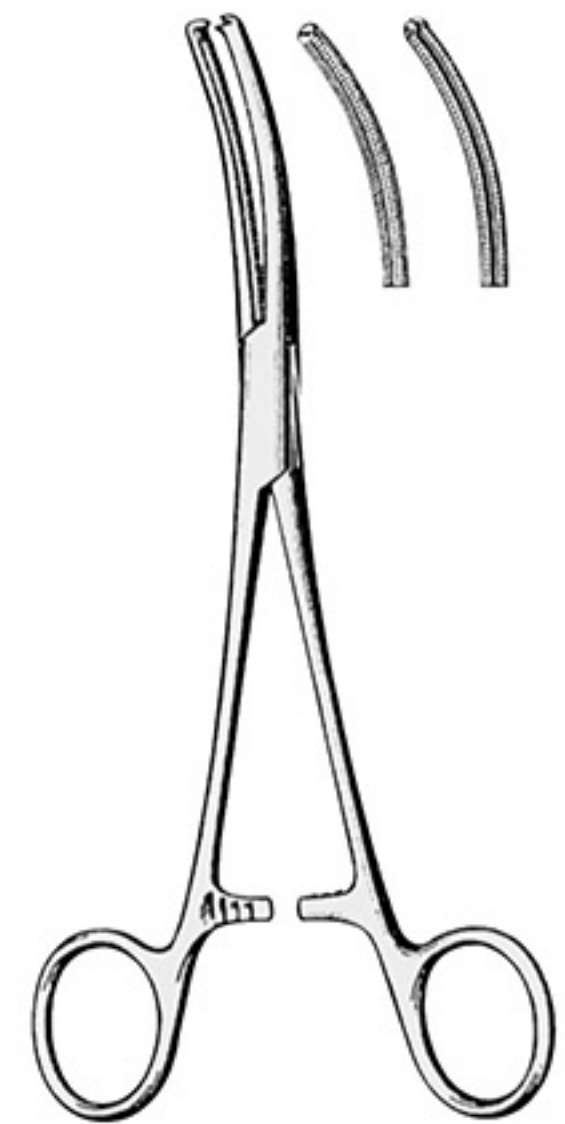

Gelpi-Lower Forceps
13-590

13-590-8.50"

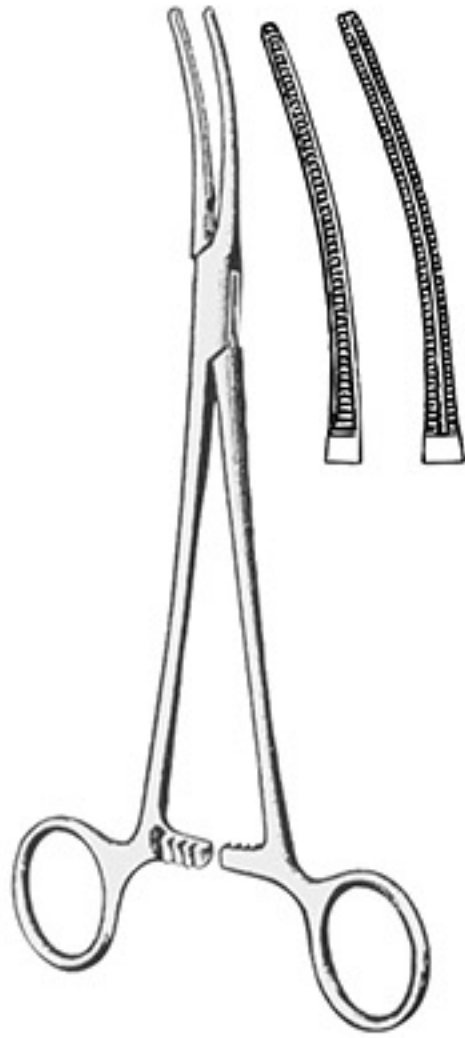

Gusberg Hystrectomy Clamp
14-591

14-591-8.00"

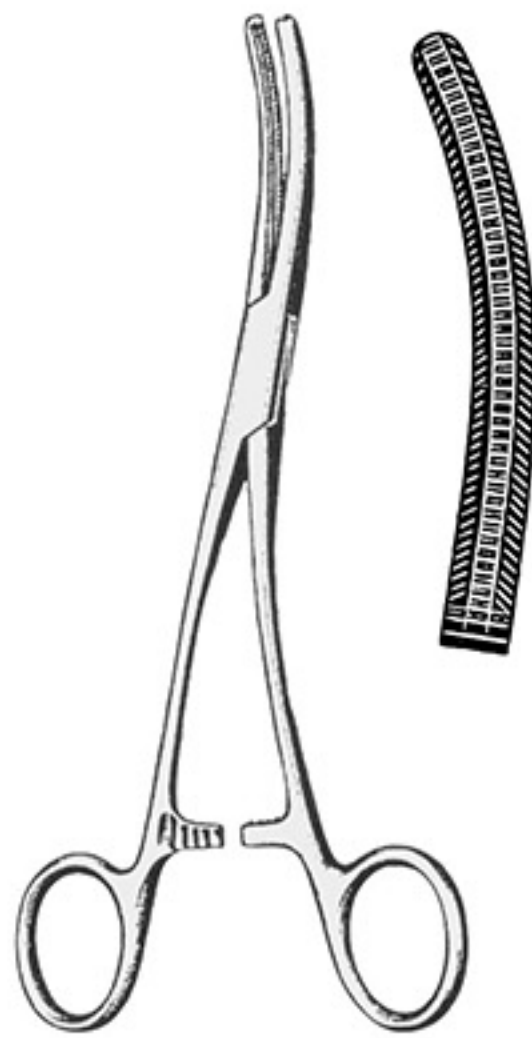

DeAlvarez
14-592

14-592-8.25" Double Curved



Heaney-Ballentine Forceps
14-593 to 14-594

14-593-8.00" Straight
14-594-8.00" Curved



Heaney Hystrectomy Forceps
14-595 to 14-598

14-595-8.00" Straight Single Tooth
14-596-8.00" Curved Single Tooth
14-597-8.00" Straight Double Tooth
14-598-8.00" Curved Double Tooth



Hartman Alligator Ear Forceps
14-746 to 14-748

14-746-4.75"
14-748-5.50"

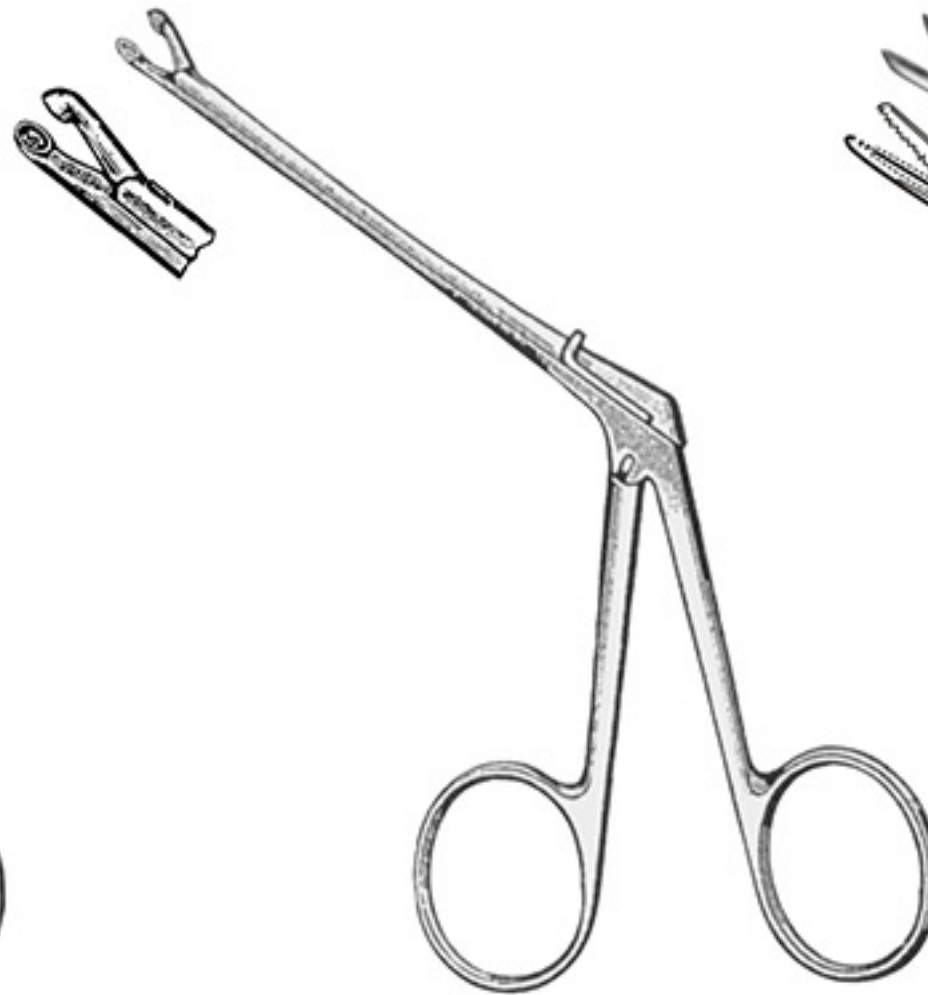

Hartman Alligator Ear Action Forceps
14-749

Cup Shape



Hartman Alligator Ear Forceps
14-750 to 14-755

14-750- 3.50"
14-752- 5.50"
14-754- 6.50"
14-755-10.00"

A TRADITION OF QUALITY A PROMISE OF VALUE.



Micro Alligator Forceps
14A-751

14A-751-3. 1/2"

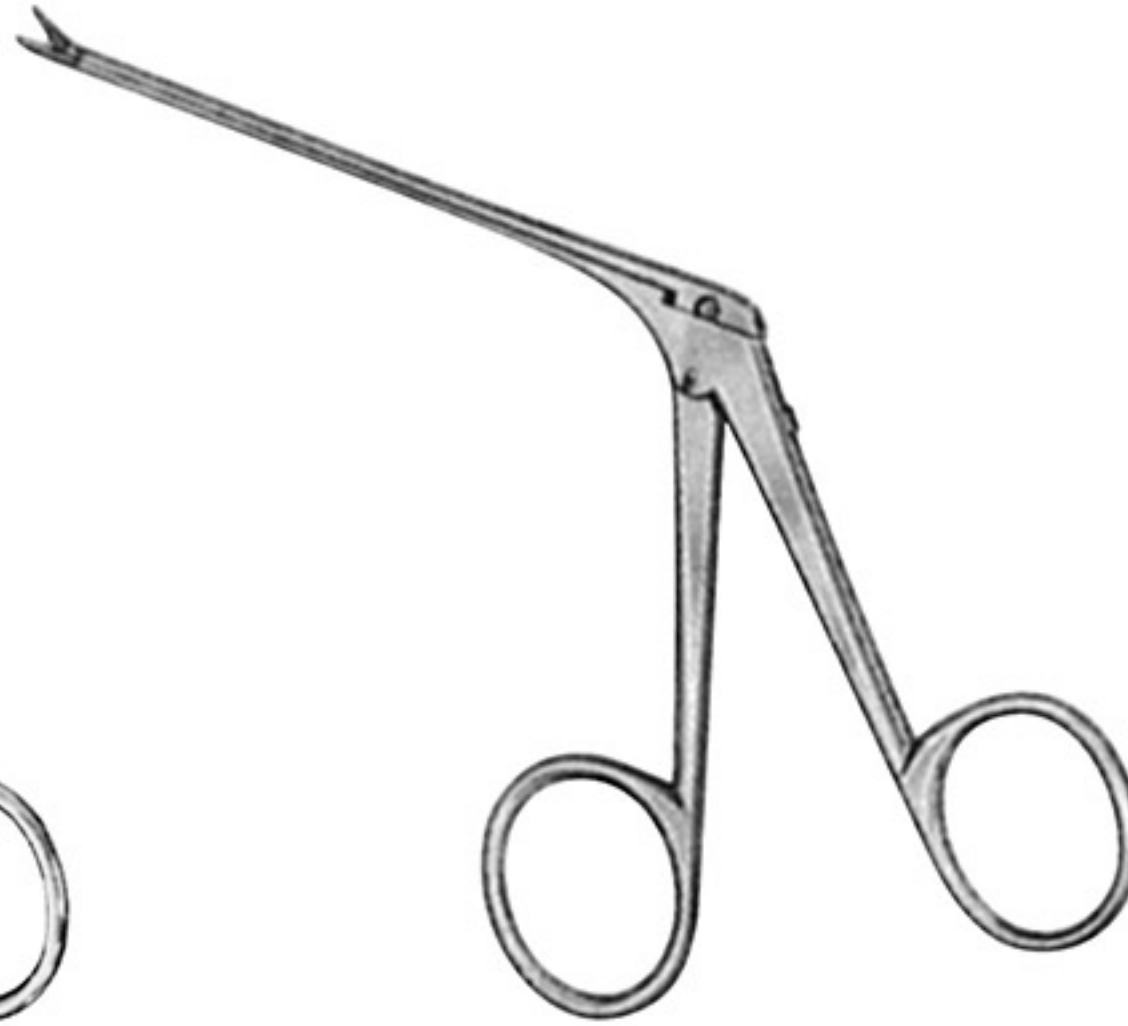

Micro Alligator Scissors
14A-752

14A-752-3 1/2"



Jones / Towel Clamp
14A-753

14A-753-3 1/2"
Slight Curved

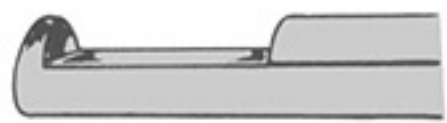

Forward 90° Thin footplate

□ 1 mm bite forward
14A-940A

□ 2 mm bite forward
14A-940B

□ 3 mm bite forward
14A-941C

□ 4 mm bite forward
14A-941D

□ 5 mm bite forward
14A-941E



Up 45° Thin footplate

□ 1 mm bite up
14A-944A

□ 2 mm bite up
14A-945B

□ 3 mm bite up
14A-946C

□ 4 mm bite up
14A-947D

□ 5 mm bite up
14A-948E



Down 90° Thin footplate

□ 1 mm bite down
14A-949A

□ 2 mm bite down
14B-950B

□ 3 mm bite down
14C-951C

□ 4 mm bite down
14D-952D

□ 5 mm bite down
14E-953E

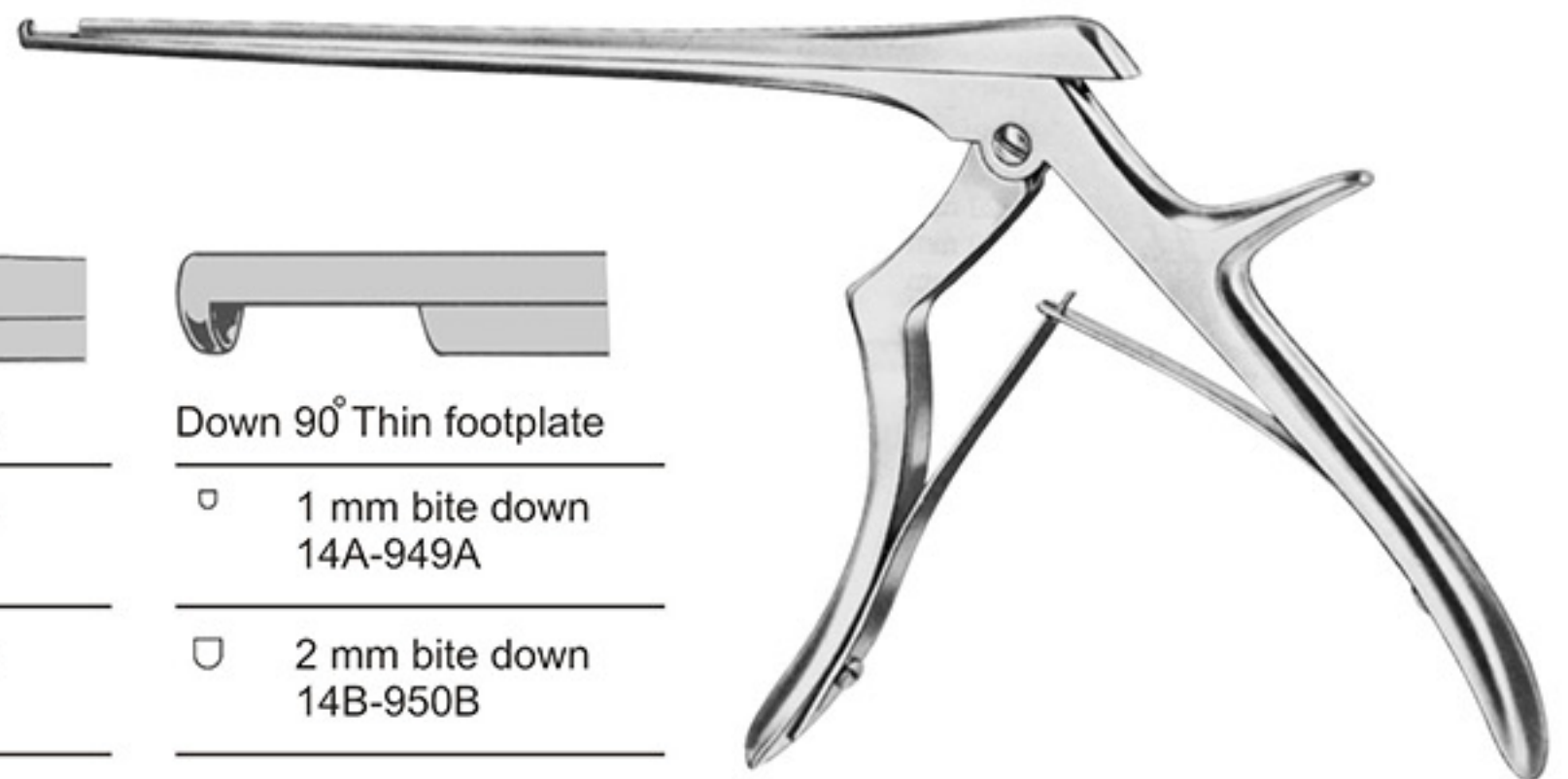

**THIN FOOTPLATE
KERRISON PUNCH / RONGERS**



Virtus Splinter Forceps
15-756 to 15-575

15-756 Straight
15-757 Curved



Davis Sterilizer Forceps
15-760 to 15-761

15-760- 6.00"
15-761-10.00"



Wachtenfeld Clip Forceps
15-762

15-762-5.00"
Cross Action



Wachtenfeld Clip Forceps
15-763

15-763-5.00"



Michel clip Applying-Removing Forceps
15-764

15-764-5.00"



4 mm
3 mm
2 mm



4 mm
3 mm
2 mm

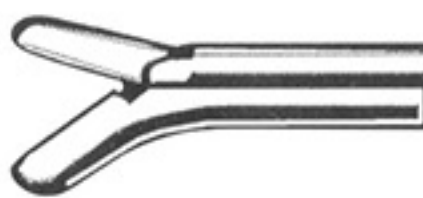

4 mm
3 mm
2 mm

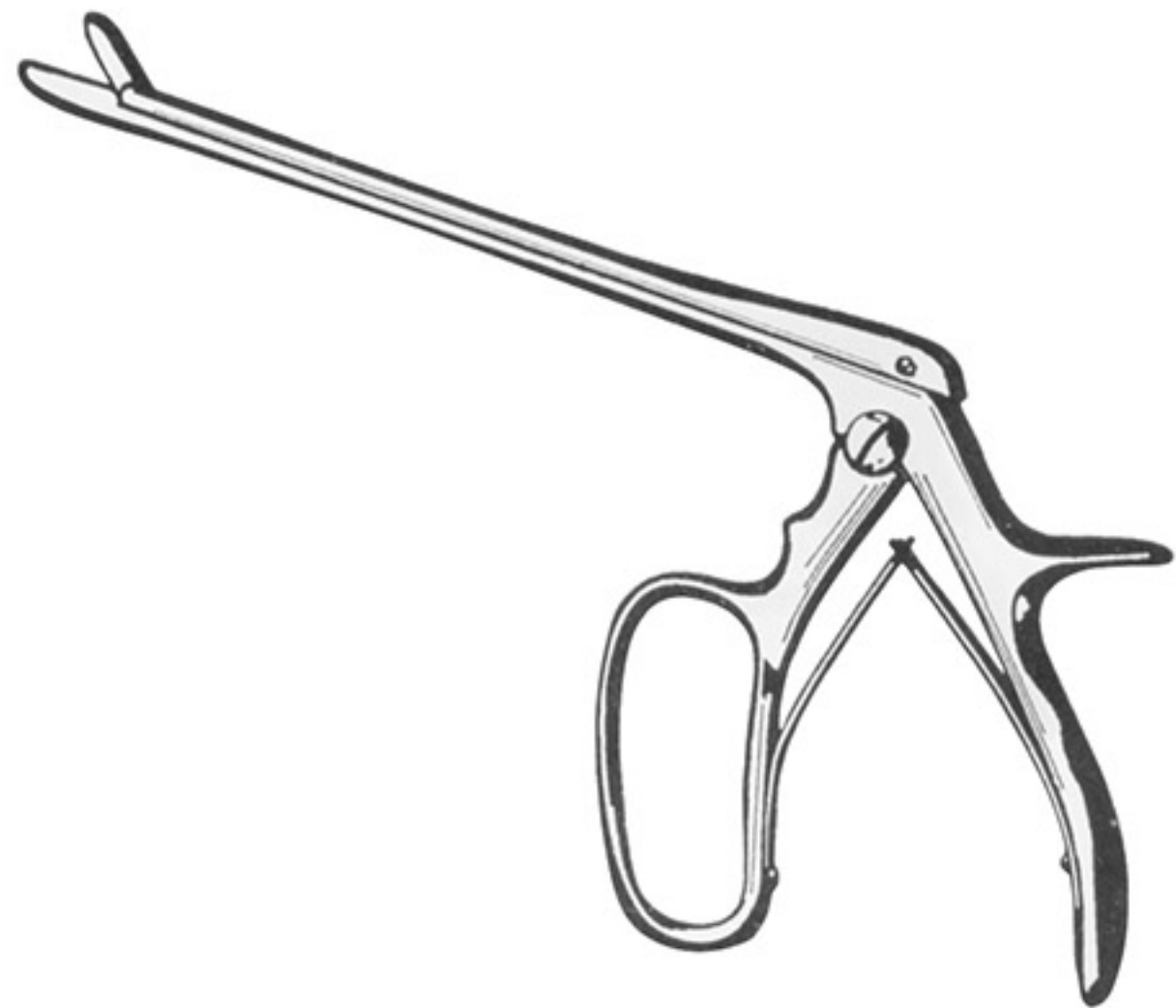

Ferris Smith Intervertebral Disc Rongeur
15-765 to 15-576

15-765-7.00" 2x10mm Straight	15-771-7.00" 4x10mm Straight
15-766-7.00" 2x10mm Up-Angle	15-772-7.00" 4x10mm Up-Angle
15-767-7.00" 2x10mm Down-Angle	15-773-7.00" 4x10mm Down-Angle
15-768-7.00" 3x10mm Straight	
15-769-7.00" 3x10mm Up-Angle	
15-770-7.00" 3x10mm Down-Angle	

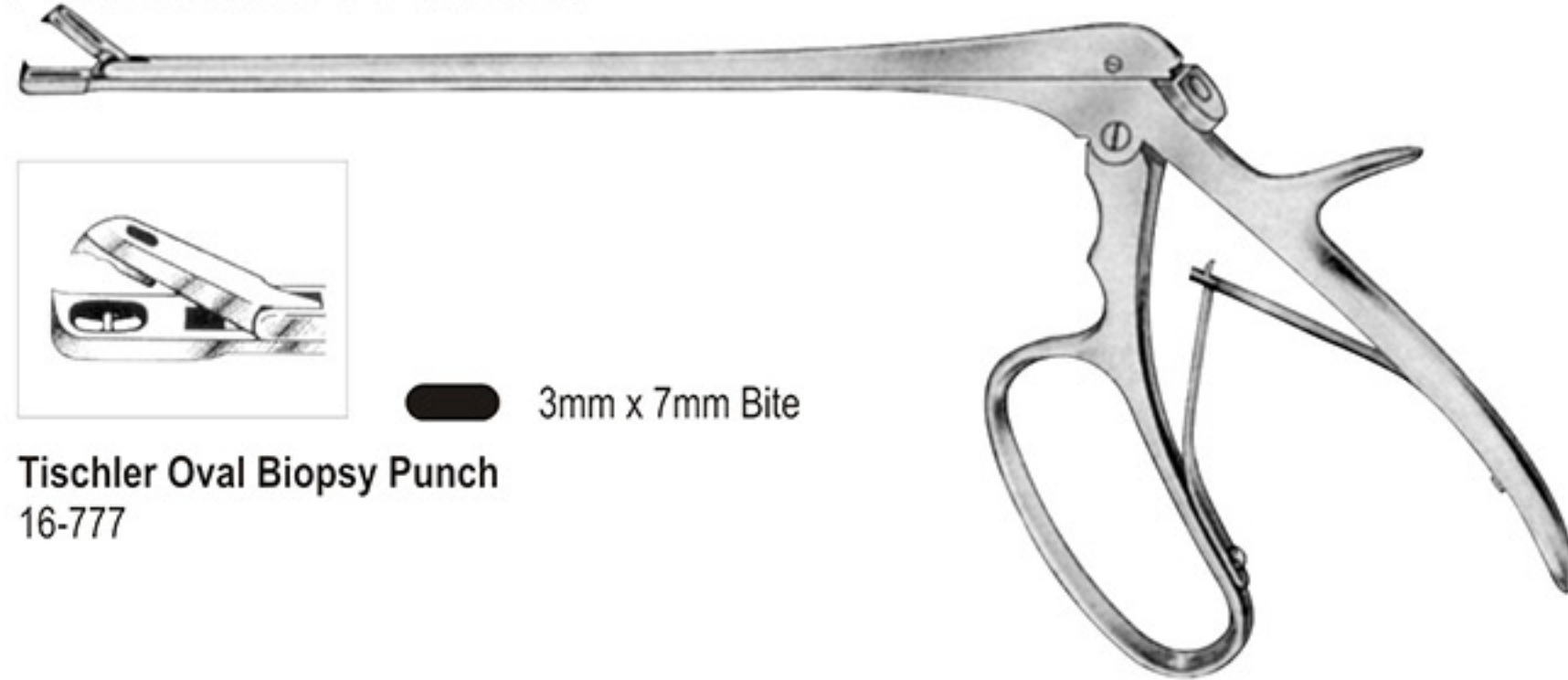

Tischler Oval Biopsy Punch
16-777

3mm x 7mm Bite

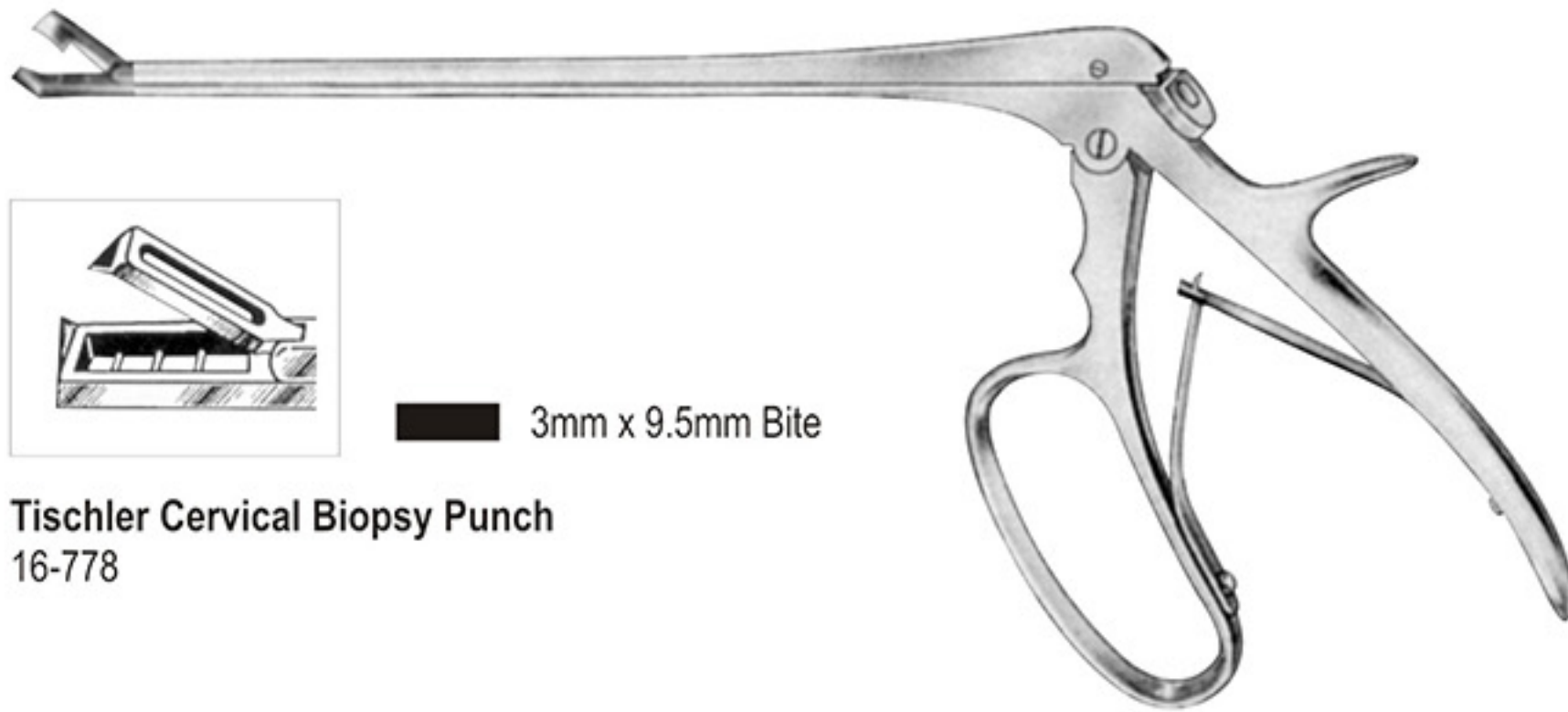

Tischler Cervical Biopsy Punch
16-778

3mm x 9.5mm Bite

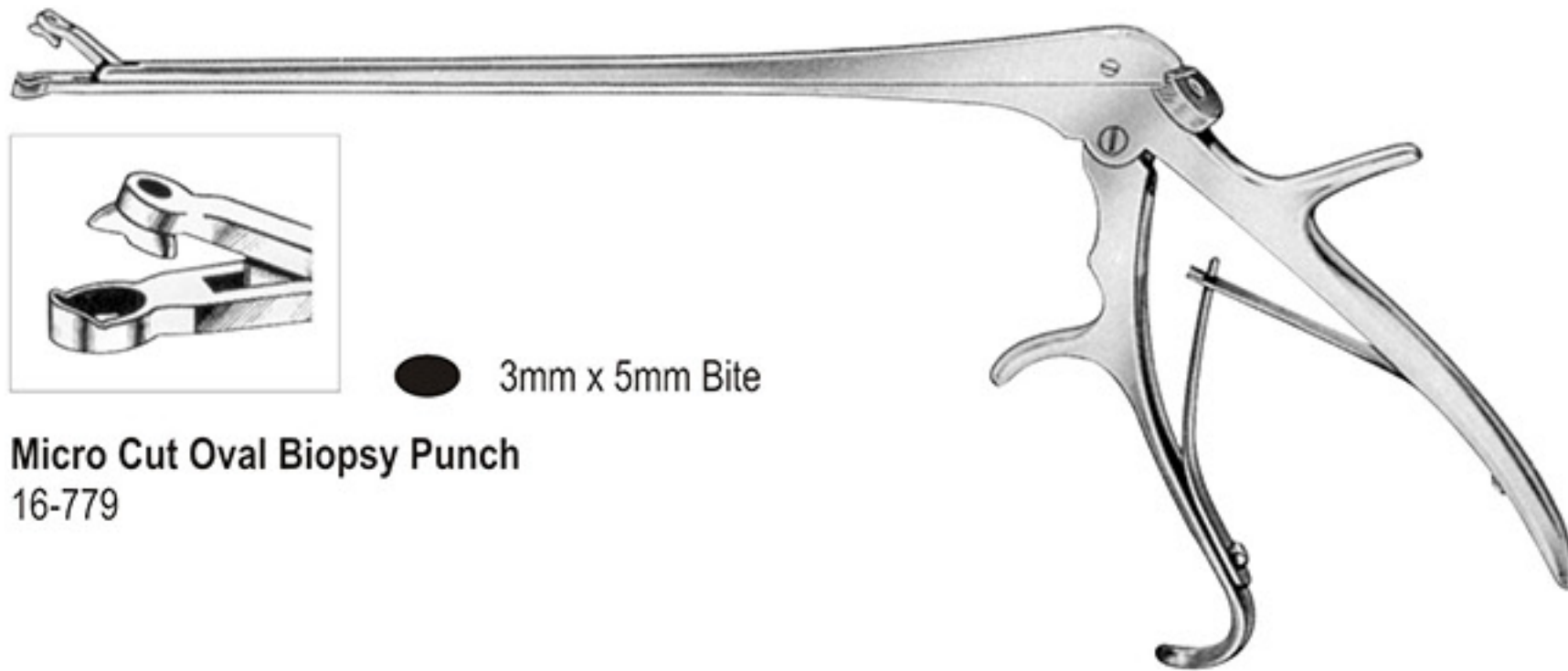

Micro Cut Oval Biopsy Punch
16-779

3mm x 5mm Bite

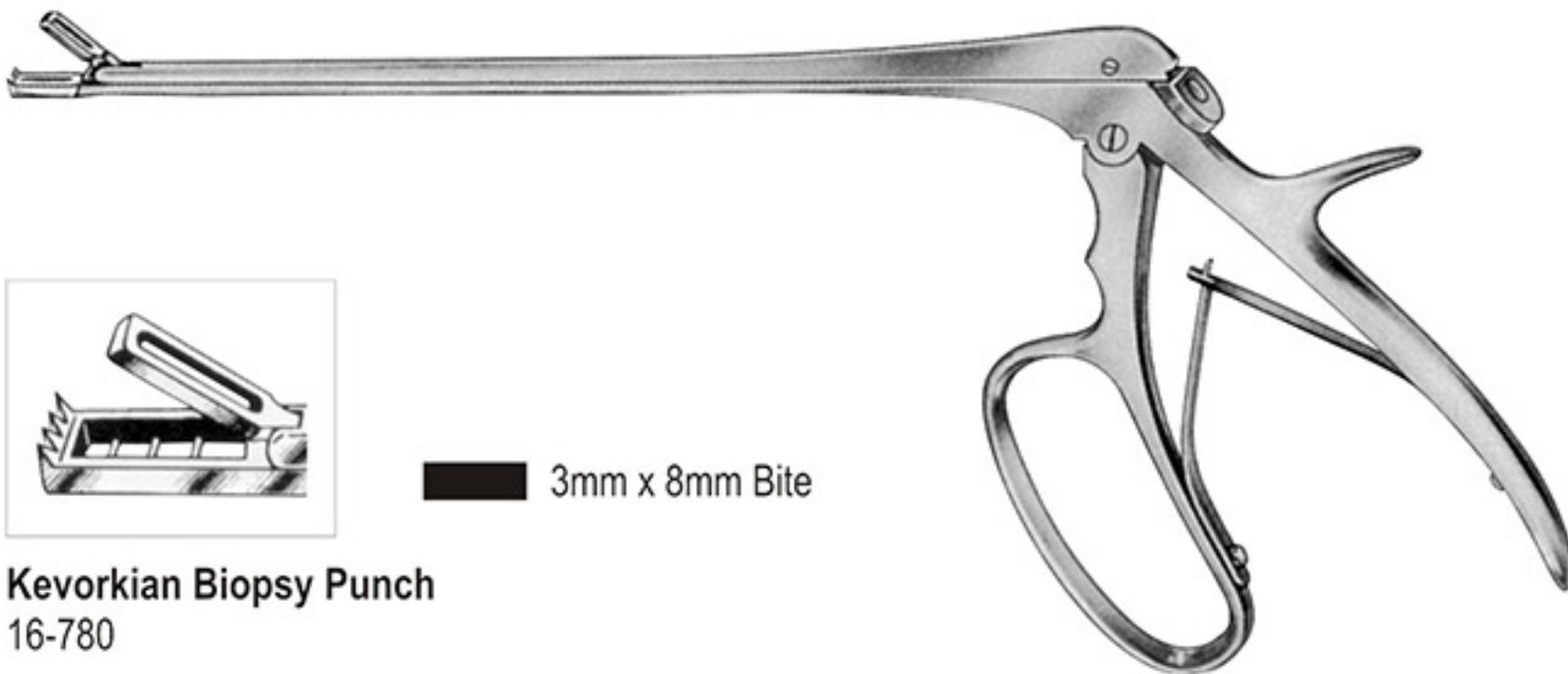

Kevorkian Biopsy Punch
16-780

3mm x 8mm Bite

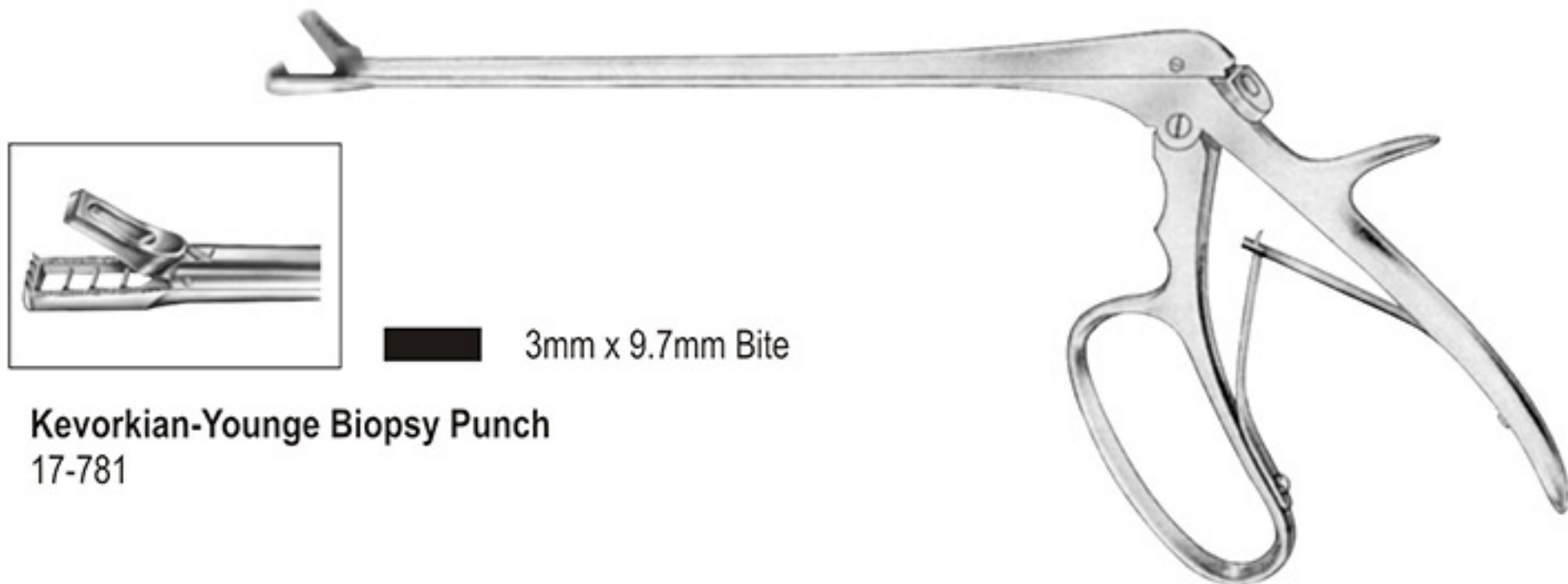

Kevorkian-Younger Biopsy Punch
17-781

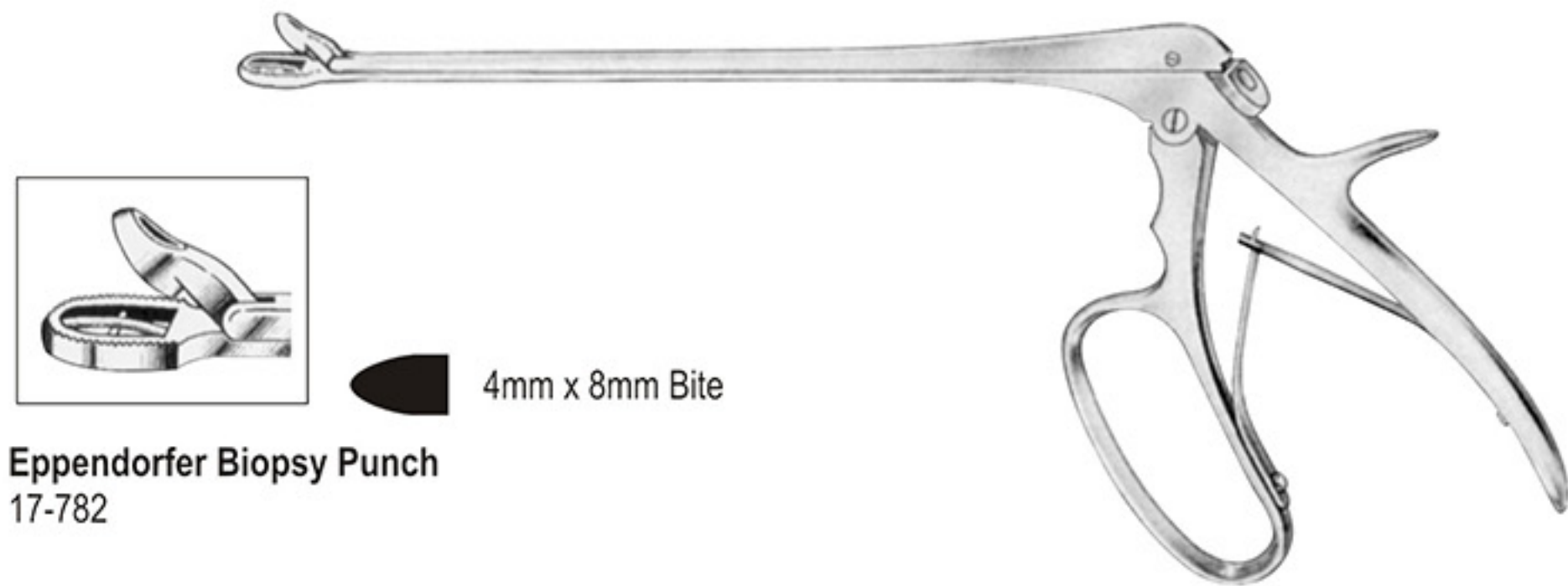

Eppendorfer Biopsy Punch
17-782

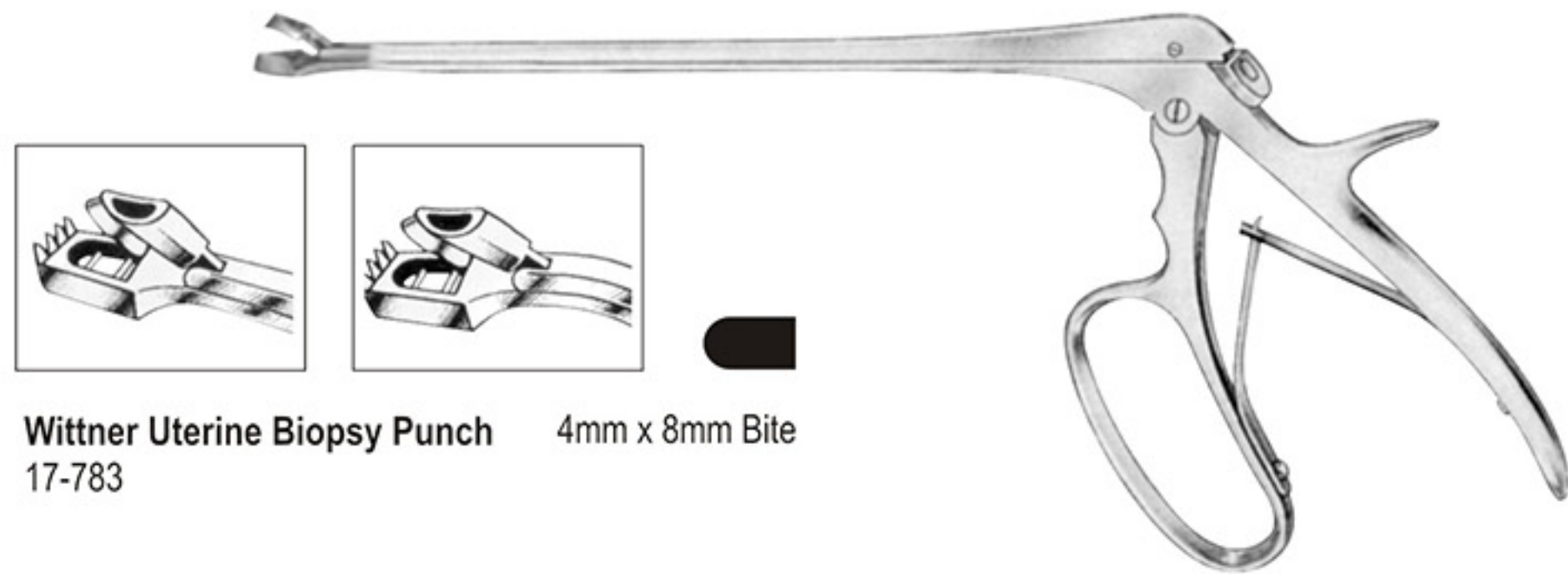

Wittner Uterine Biopsy Punch 4mm x 8mm Bite
17-783

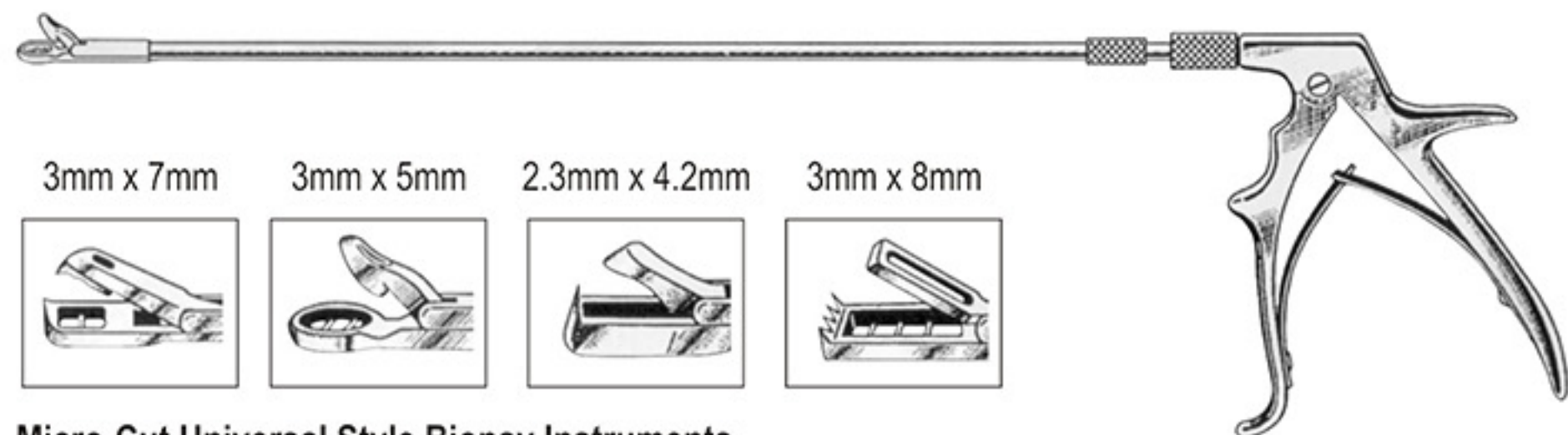

Micro-Cut Universal Style Biopsy Instruments

- | | | | |
|--------------------|---------------|------------------------|---------------|
| 17-784 to 17-787 | | | |
| 17-784 - 3mm x 7mm | 7mm Bite Oval | 17-786 - 2.3mm x 4.2mm | Bite Tischler |
| 17-785 - 3mm x 5mm | Bite Oval | 17-787 - 3mm x 8mm | Bit Tischler |

A TRADITION OF QUALITY A PROMISE OF VALUE.

Gaylor Biopsy Punch

18-788 to 18-789

 18-788 - 8.50" Micro
 18-789 - 8.50" Micro-Cut

Thoms-Gaylor Uterine Forceps

18-790

18-790 - 10.00"

Gelhorn Biopsy Punch

18-791 to 18-792

 18-791 - 9.50" Micro
 18-792 - 9.50" Micro-Cut

Wartenberg Pinwheel

18-802

18-802 - 7.25"

Taylor Percussion Hammer

18-804

18-804 - 7.25"

Pinard

18-956A

18A-956-7.00"

Troemner Neurological Hammer

18-805

Buck Neurological Hammer

18-806

18-806 - 7.00"

Dejerine Neurological Hammer

18-807

Babenski Neurological Hammer

18-808 to 18-812

 18-808 - 7.00" W / Pin
 18-809 - 9.00" W / out Pin
 18-810 - 7.00" Plastic Handle
 18-812 - 9.00" Plastic Handle

Finger Ring Cutter

18-814 - 18-816

 18-814- 6.25" With Circular Sew Blade
 18-816- 6.25" Ring Cutter Blade Only

A TRADITION OF QUALITY A PROMISE OF VALUE.

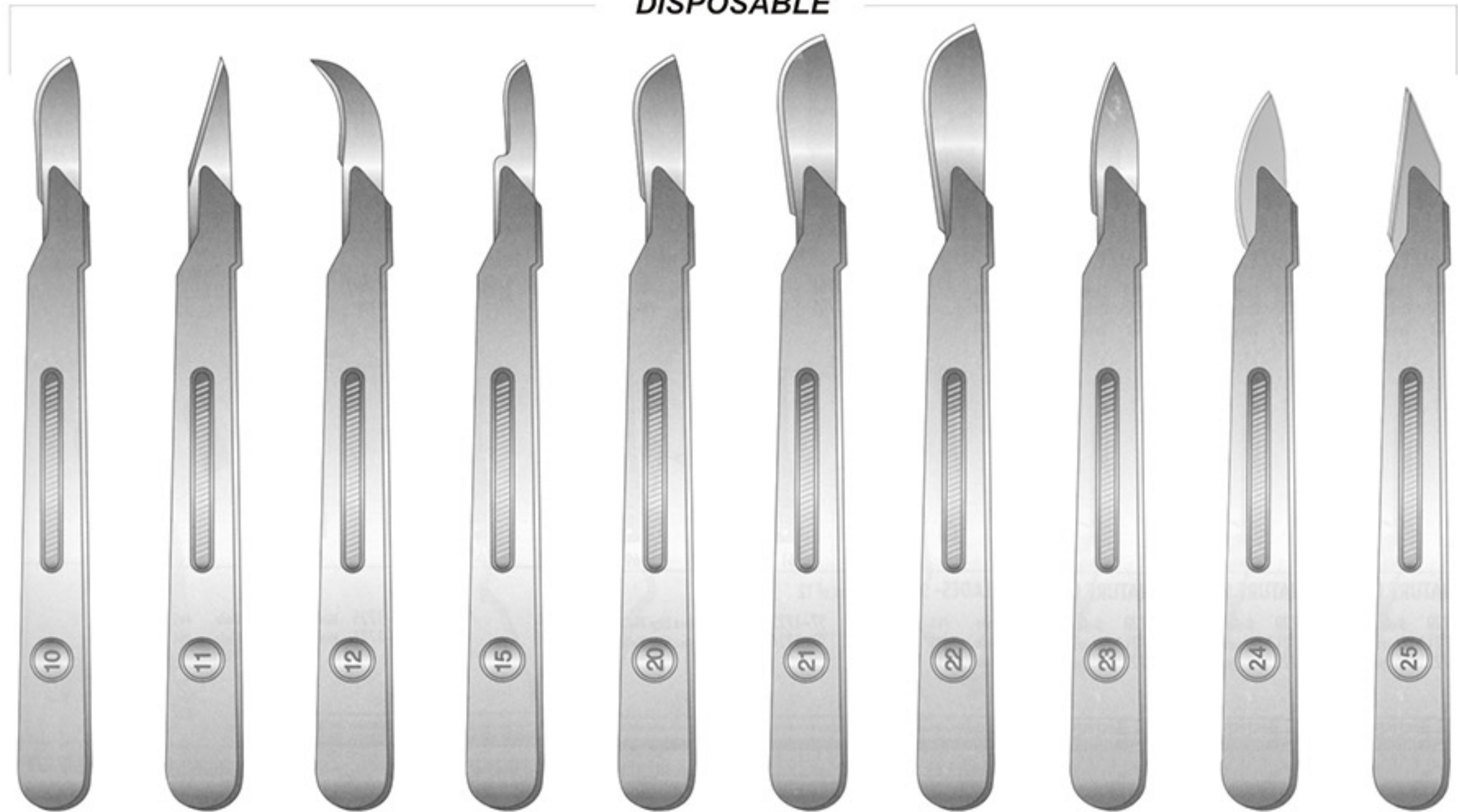

Scalpel Handle	Scalpel Handle	Scalpel Handle	Scalpel Handle	Scalpel Handle	Scalpel Handle	Scalpel Plastic Handle	Scalpel Plastic Handle
18A-824LA	18A-824L	18A-826LA	18A-826L	18A-824B	18A-826B	18A-824P	18A-826P
18A-824LA # 3 LA	18A-824L # 3 L	18A-826LA # 4 LA	18A-826L # 4 L	18A-824B # 8	18A-826B # 9	18A-824P # 5	18A-826P # 6

DISPOSABLE

18A-SB10 18A-SB11 18A-SB12 18A-SB15 18A-SB20 18A-SB21 18A-SB22 18A-SB23 18A-SB24 18A-SB25

Disposable Scalpel - Sterile, pack of 10



Scalpel Handle
19-823

19-823-# 3 with Scale



Scalpel Handle
19-824

19-824-# 3



Scalpel Handle
19-826

19-826-# 4

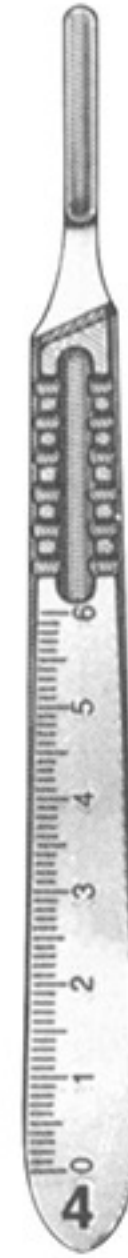

Scalpel Handle (with scale)
19-826 S

19-826S-# 4



Scalpel Handle
19-828

19-828-# 7



Scalpel Handle
19-829A

19-829A-4.5"
Round Handle



Scalpel Handle
19-829B

19-829B-6.25"
Round Handle



Scalpel Handle
19-829C

19-829C-5"
Round Handle



Scalpel Handle
19-829D

19-829D-4.25"
Round Handle



Scalpel Handle
19-829E

19-829E-5"
Round Handle



Scalpel Handle
19-829F

19-829F-5.25"
Round Handle



Scalpel Handle
19-829G

19-829G-4.75"
Round Handle

Scalpel Blades Sterile Carbon Steel. Pack of 100 Blades / Good for Handle # 3, 3L, 3S, 5, 7



19A-SB-10

19A-SB-11

19A-SB-12

19A-SB-15

19A-SB-16

Scalpel Blades Sterile Carbon Steel. Pack of 100 Blades / Good for Handle # 4, 4L, 4S, 6



Blade # 60 & 70 is also available

19A-SB-20

19A-SB-21

19A-SB-22

19A-SB-23

19A-SB-24

19A-SB-25

19A-SB-60
19A-SB-70

A TRADITION OF QUALITY A PROMISE OF VALUE.



Fig. 00
20-864 / Mac 00
working length
55mm



Fig. 0
20-864 / Mac 0
working length
75mm



Fig. 1
20-864 / Mac 1
working length
90mm



Fig. 2
20-864 / Mac 2
working length
110mm



Fig. 3
20-864 / Mac 3



Fig. 4
20-864 / Mac 4



Fig. 00
20-864 / Mil 00



Fig. 0
20-864 / Mil 0



Fig. 1
20-864 / Mil 1



Fig. 2
20-864 / Mil 2



Fig. 3
20-864 / Mil 3



Fig. 4
20-864 / Mil 4



Laryngoscope Handle



20-864 / BS
Small Bulb



20-864 / BL
Large Bulb



20-864 / Mac Set
Set of 5 Pcs.



20-864 / Mill Set
Set of 5 Pcs.

20-864 / H.S - Small Handle AA
20-864 / H.M - Medium Handle C
20-864 / H.L - Large Handle D

A TRADITION OF QUALITY A PROMISE OF VALUE.



Laryngoscope
Handle-Fiber optic

20-864 / F.H.S - Fiber optic Small handle
20-864 / F.H.M - Fiber optic Medium handle



Fiberoptic Set McIntoch
20A-864-FMC SET
with four laryngoscope
blades No. 1 to 4 + 1 Handle
complete, in case.



Fiberoptic Miller Set
20A-864-FMIL SET
with accumulator handle and
three laryngoscope blades
No. 0 to 4 + 1 Handle
complete, in case.



DIAGNOSTIC SET
(colors available)

20C-2100
Oto Scope



DIAGNOSTIC SET

20C-2102
Oto Scope Plastic



DIAGNOSTIC SET

20C-2101
Matal Oto Scope



DIAGNOSTIC SET

20C-2103
Ophthalmoscope



DIAGNOSTIC SET

20C-2104
Oto Scope / Ophthalmoscope
Complete Set



DIAGNOSTIC SET

20C-2105
Oto Scope

Conventional Set

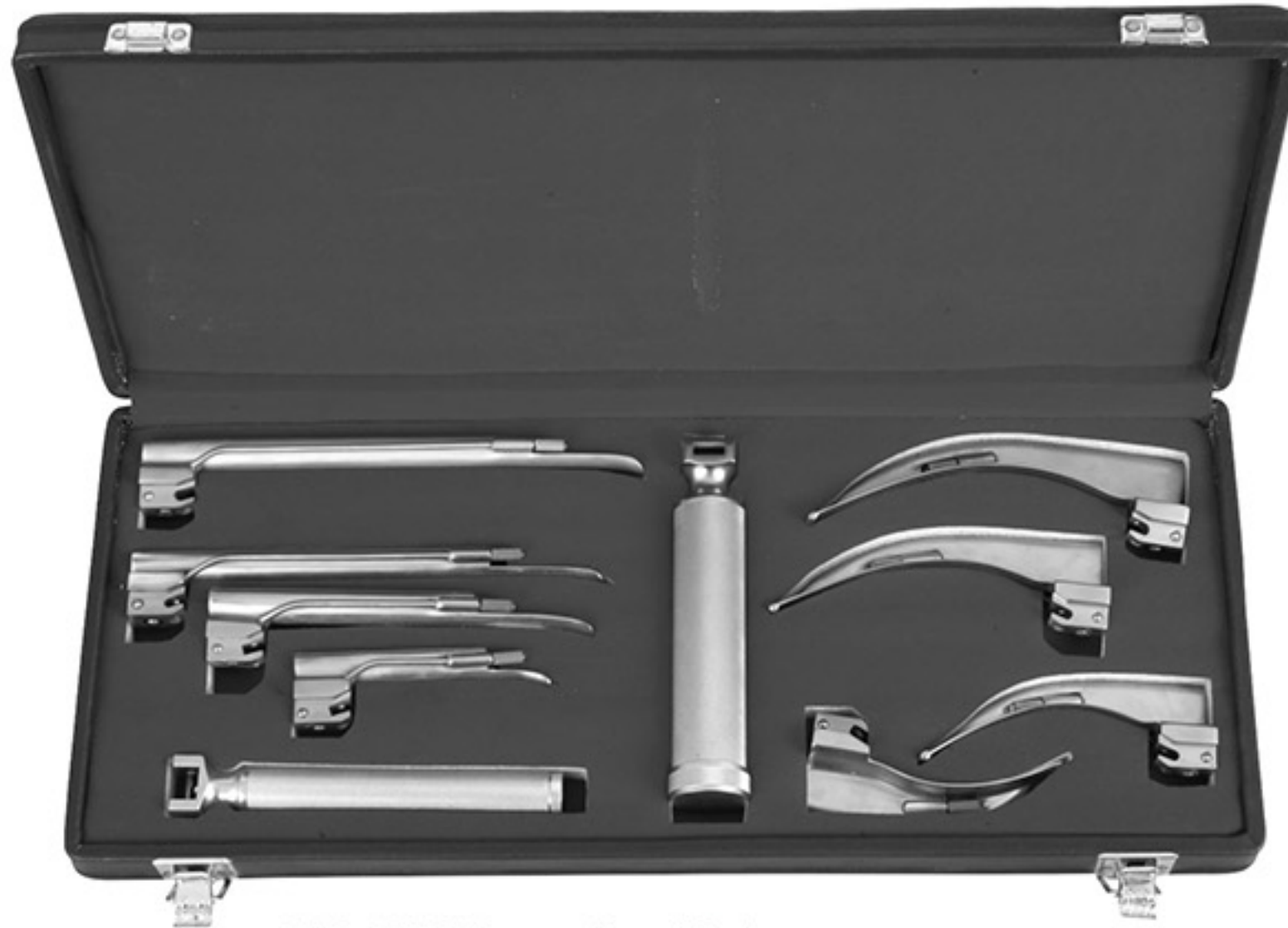

**20C-864D Conventional Set,
Mac + Miller Combo Double Set of 10 Pcs.**
4 Miller Blades
4 Mac Blades
1 Handle Small
1 Handle Medium

Fiberoptic Set

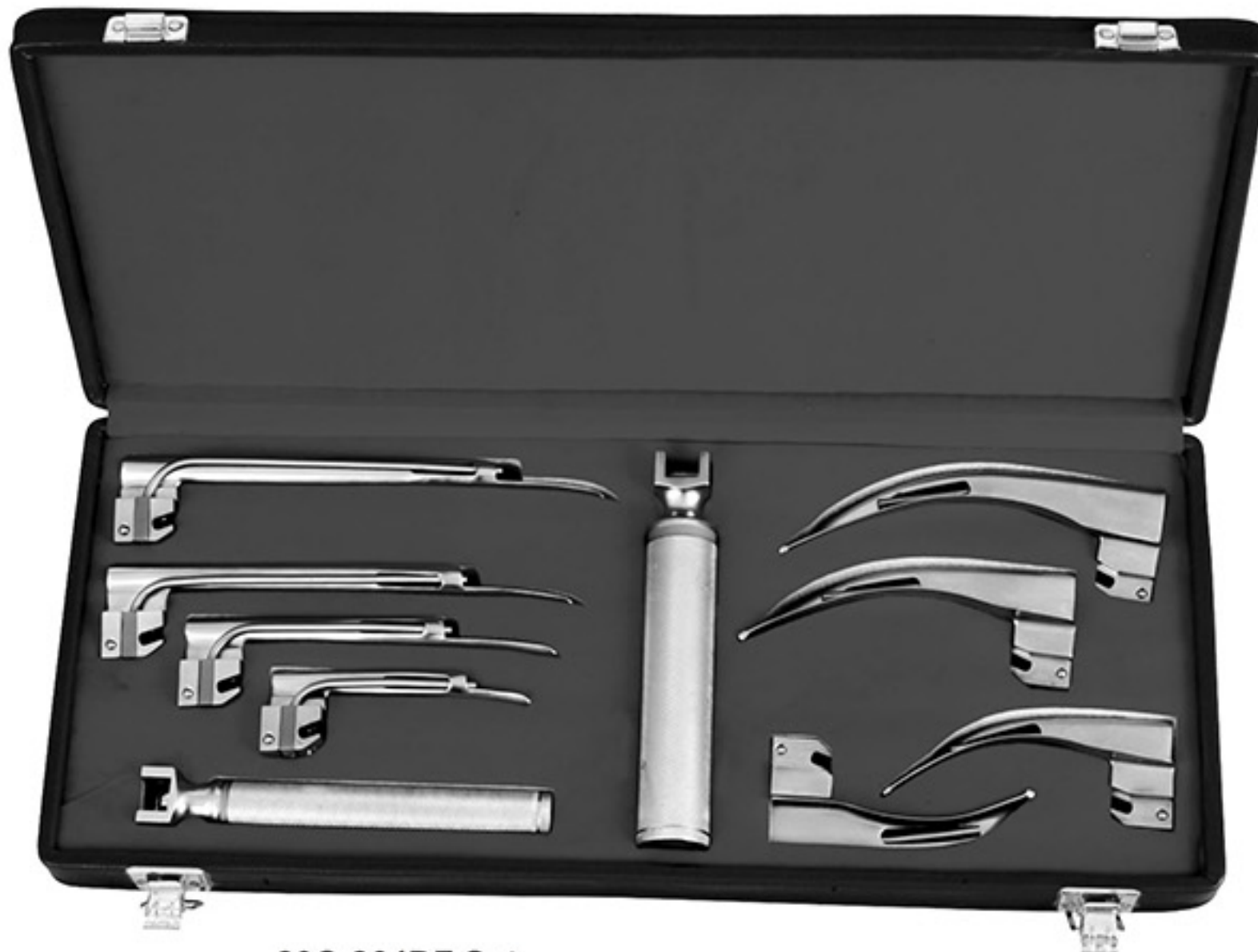

**20C-864DF Set
Mac + Miller Combo Double Set of 10 Pcs.**
4 Miller Blades
4 Mac Blades
1 Handle Small
1 Handle Medium

WE CAN ALSO MAKE CUSTOM SETS.



Fiberoptic Sets



20D-864F Mac Set
Set of 5 pcs.



20D-864F Miller Set
Set of 5 pcs.

Economy Laryngoscope Sets



20D-864 Mac Economy Set
Set of 4 Blade + 1 Handle



20D-864 Miller Economy Set
Set of 4 Blade + 1 Handle

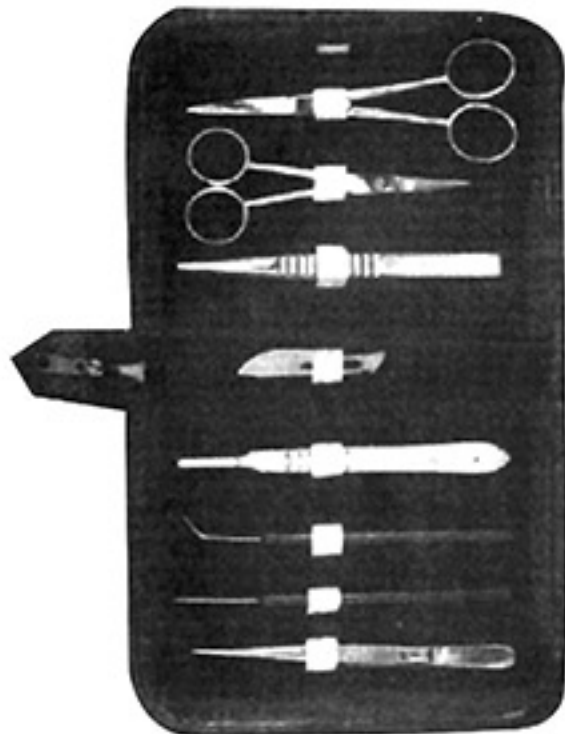

- 21-937A**
Set of 9 Pcs.
- Dissecting Forceps 11.5cms Sharp Point.
 - Teasing needle Sharp STR.
 - B.P Handle No.4.
 - Teasing Needle Sharp Angular.
 - Blade No. 22.
 - Thumb Forcep T.O.E 13cms.
 - Dissecting Scissor STR 11.5cms.
 - Dissecting Scissor STR 13cms.
 - Zipper Case

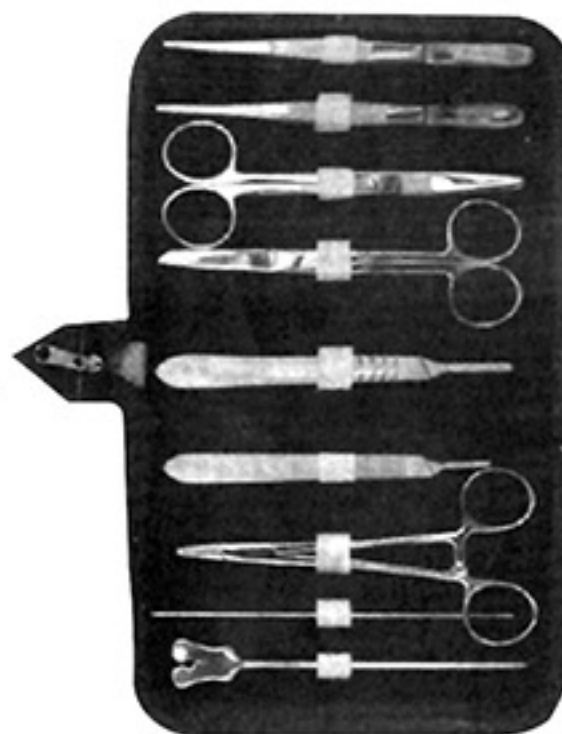

- 21-937B**
Set of 10 Pcs.
- Grooved Director Eith Tongue Tie 14cms.
 - Probe Double 14cms.
 - Mayo Hegar Needle Holder 14cms.
 - B.P Handle No.3
 - B.P Handle No.4
 - Dressing Scissor 14cms S/B STR.
 - Dressing Scissor 14cms S/B CVD.
 - Dressing Forcep 1x2 teeth 14cms.
 - Dressing Forcep Serrated 14cms.
 - Zipper Case



- 21-937C**
Set of 10 Pcs.
- Probe Double 13cms.
 - 2PCS. Scalpel S.S.
 - Grooved Director With Tongue Tie 13cms
 - Mayo Hegar Needle Holder 13cms.
 - Dissecting Forcep 13cms 1x2 Teeth.
 - Dressing Forcep 13cms Serrated.
 - Dressing Scissor 13cms S/B STR.
 - Dressing Scissor 13cms S/B CVD.
 - Zipper Case Inside Red Velvet.



- 21-937D**
Set of 10 Pcs.
- Blow Pipe.
 - 3PCS Scalpel.
 - Dissecting Forcep 13cms.
 - Grooved Director With Tongue Tie 13cms
 - Triple Chain Hook.
 - Dressing Scissor Probe Pointed 13cms.
 - Probe Double 13 cms.
 - Zipper Case Inside Red Velvet.

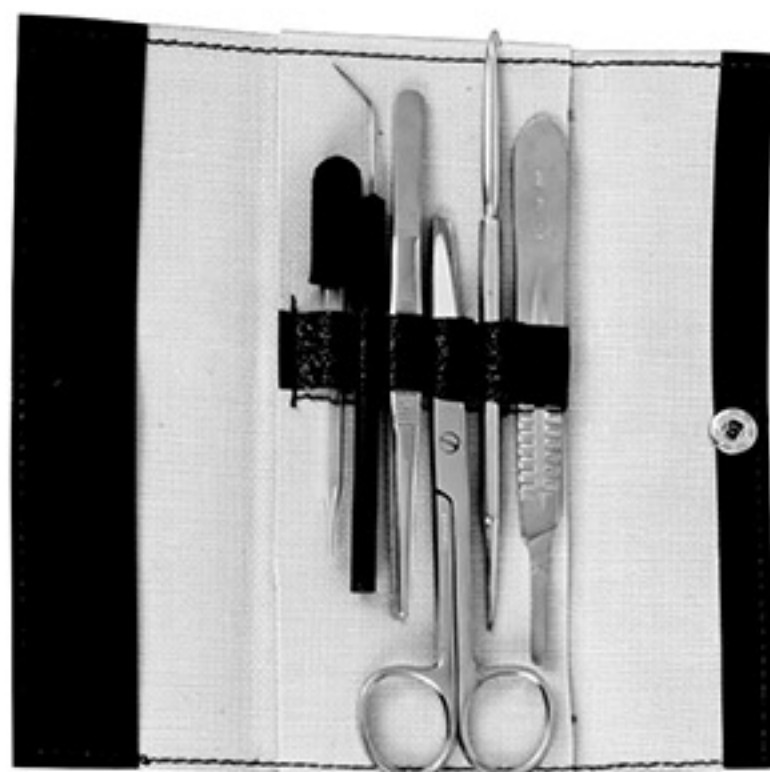

21-933
set of 6

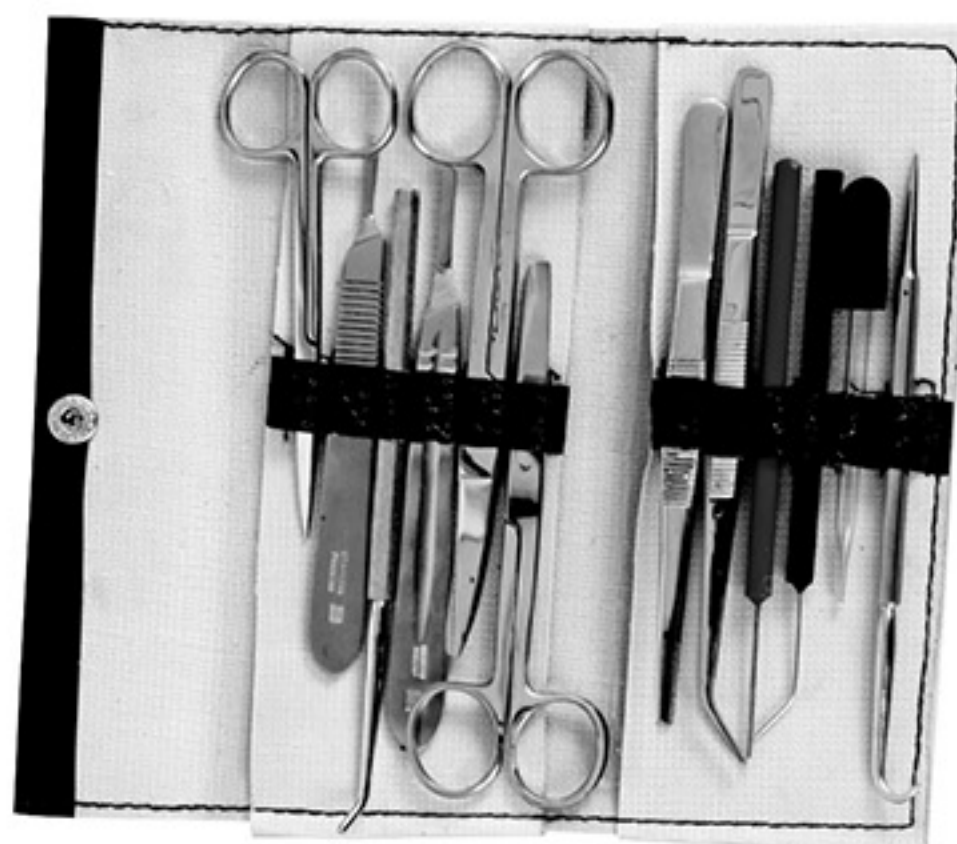

21-933A
set of 12



21-936

Dissecting Set
21-933 to 21-936

21-933 Set of 6 pcs.
21-933A Set of 12 pcs.

21-934-108 Containing 8 Instruments
21-935-109 Containing 9 Instruments
21-936-113 Containing 12 Instruments

WE CAN MAKE ALL KINDS OF CUSTOM INSTRUMENTS PACKS, SETS & TRAYS.

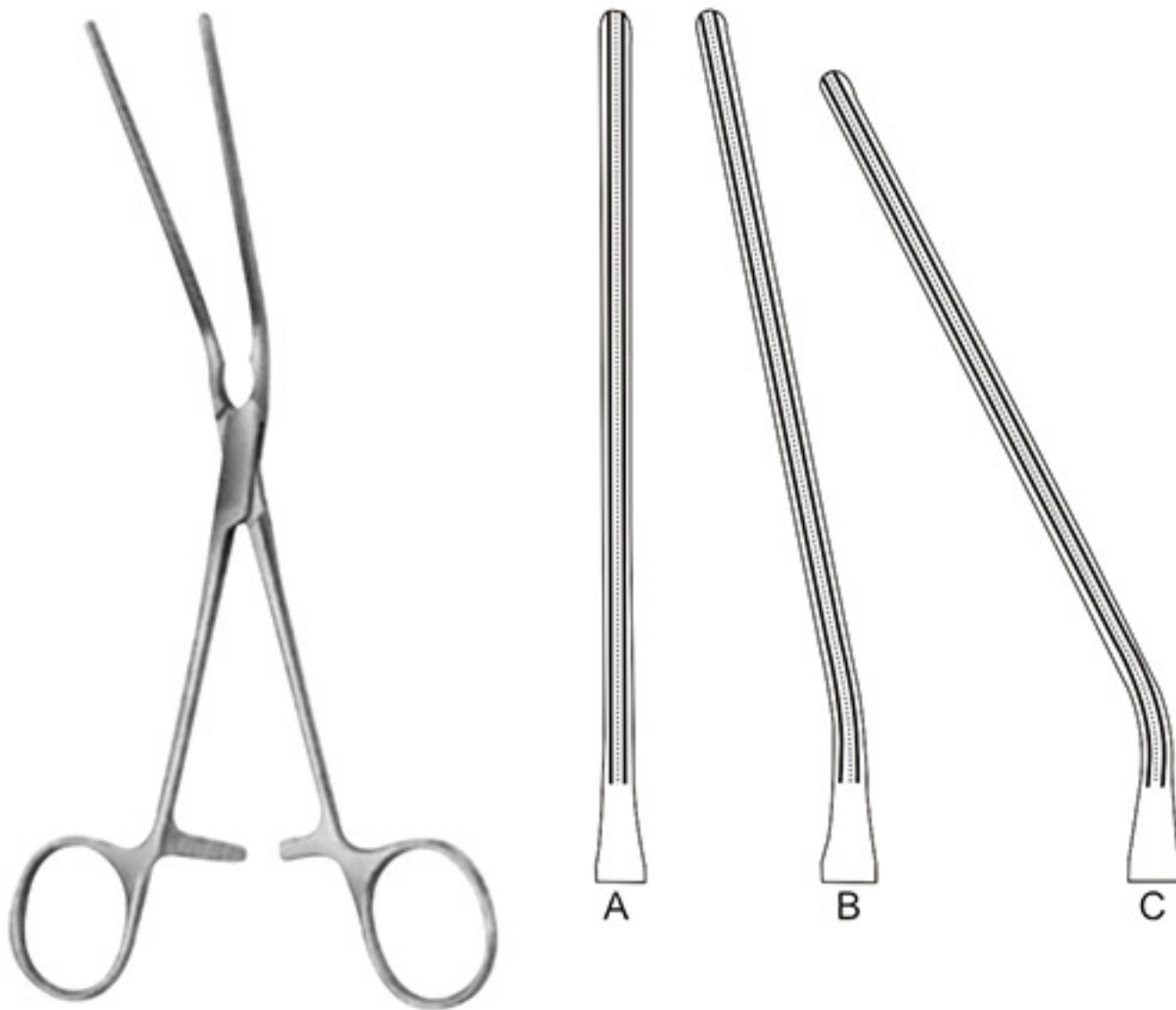

Debakey Atraumatic Forceps

22-1001 to 22-1003

- 22-1001-7.50" Straight (A)
- 22-1002-7.50" Angle 15° (B)
- 22-1003-7.50" Angle 30° (C)



Debakey Atraumatic Forceps

22-1004

22-1004-6.00" Full Curved

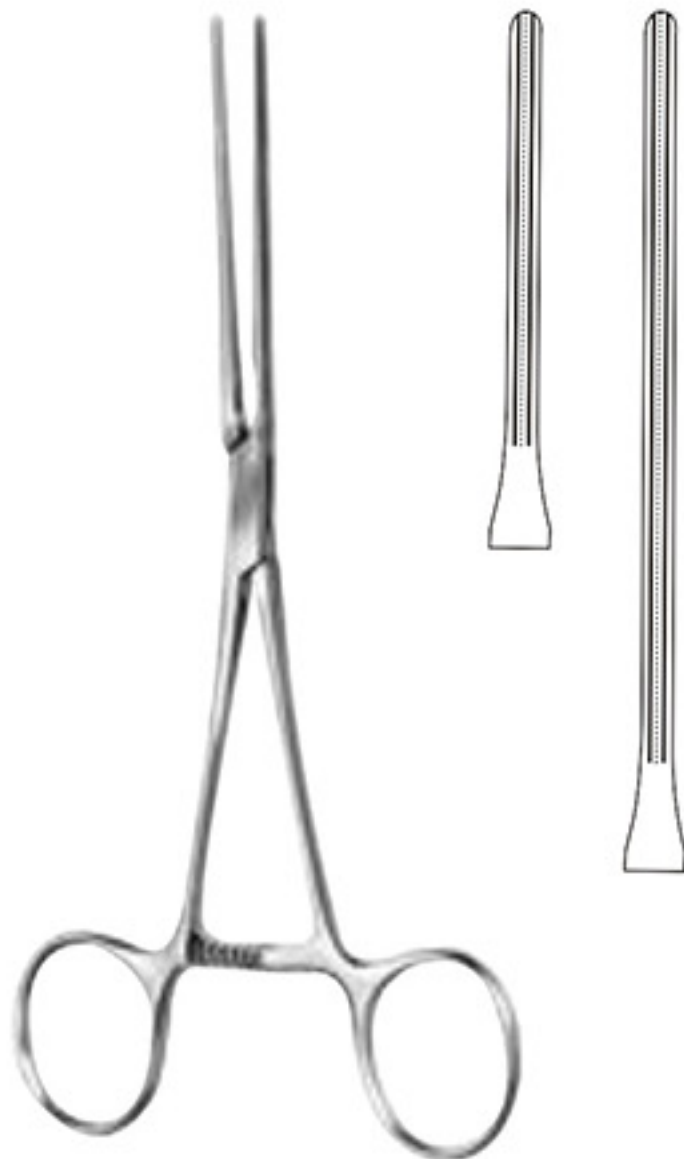

Debakey Atraumatic Forceps

22-1005 to 22-1006

- 22-1005-8.25" Straight Patent
- 22-1006-8.25" Straight Coarctation

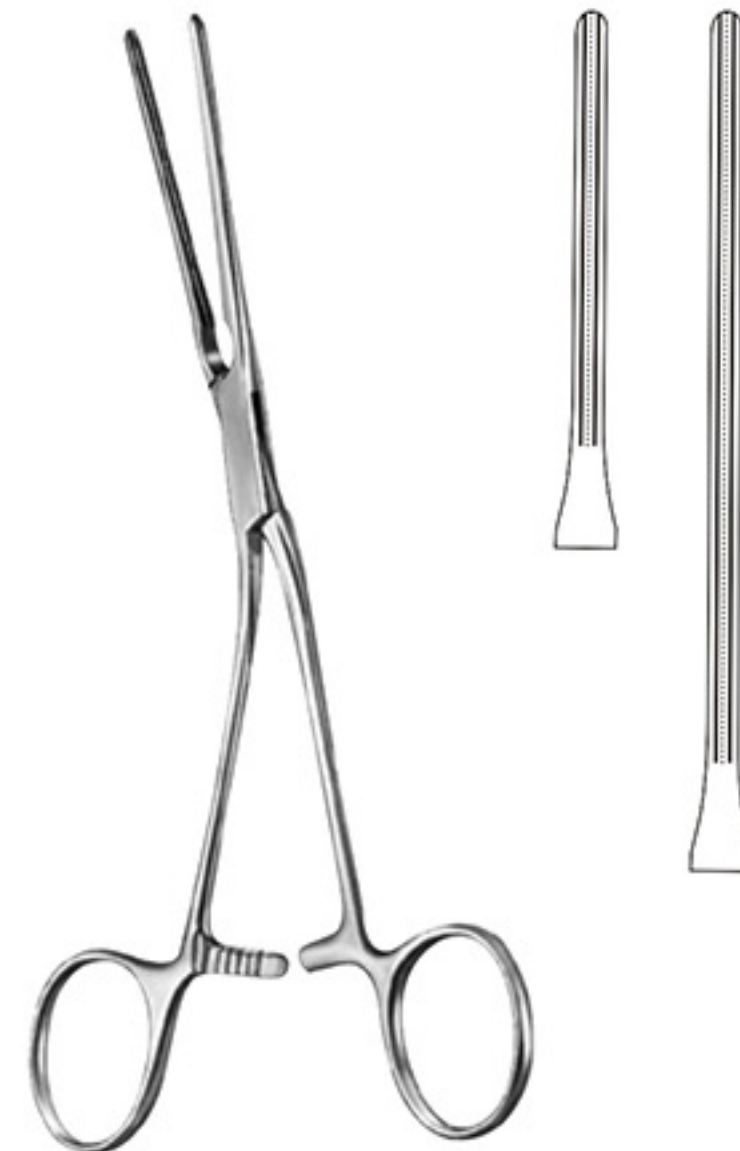

Debakey Atraumatic Forceps

22-1007 to 22-1008

- 22-1007-8.25" Angular Patent
- 22-1008-8.25" Angular Coarctation

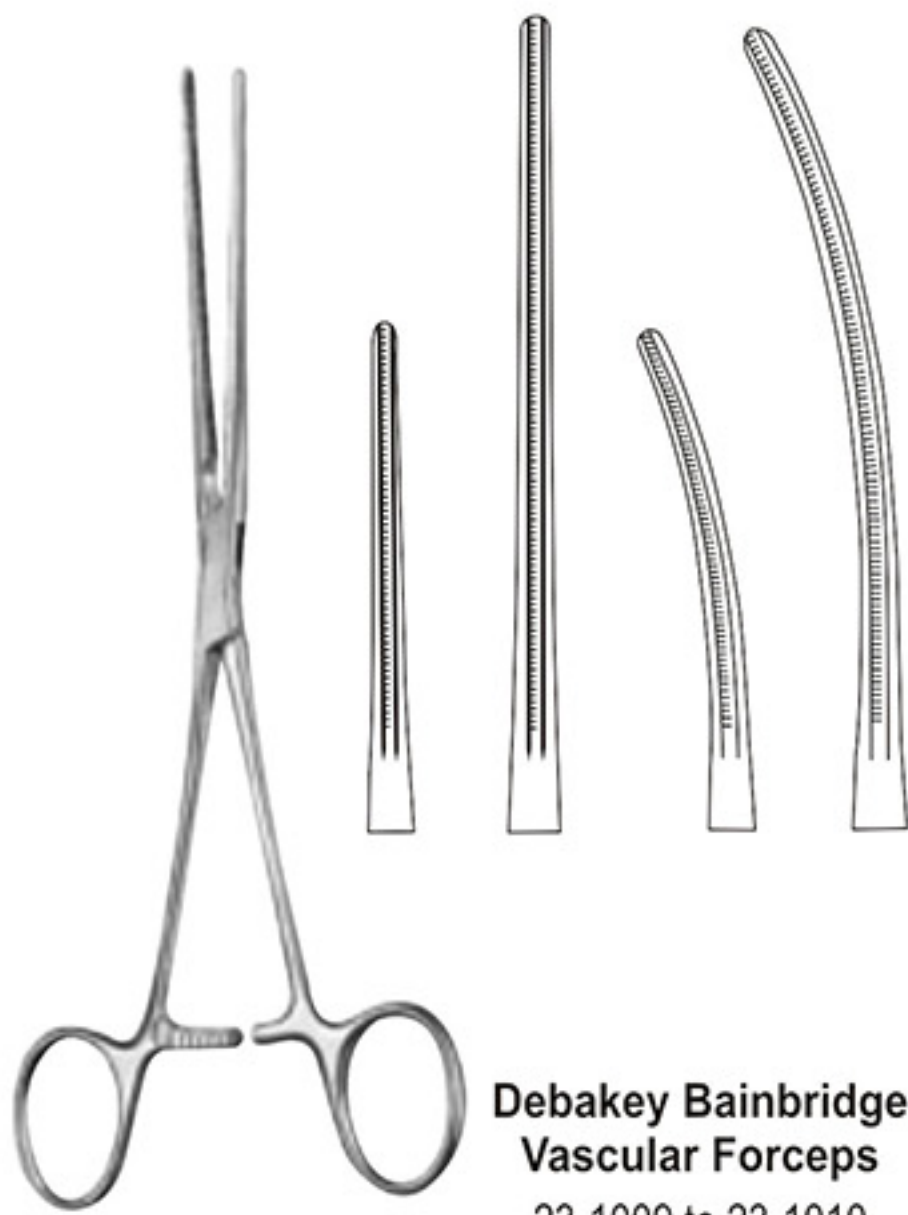

Debakey Bainbridge Vascular Forceps

23-1009 to 23-1010

- 23-1009- 6.00" str.
- 23-1010- 7.00" str.
- 23-1009A-6.00" cvd.
- 23-1010A-7.00" cvd.

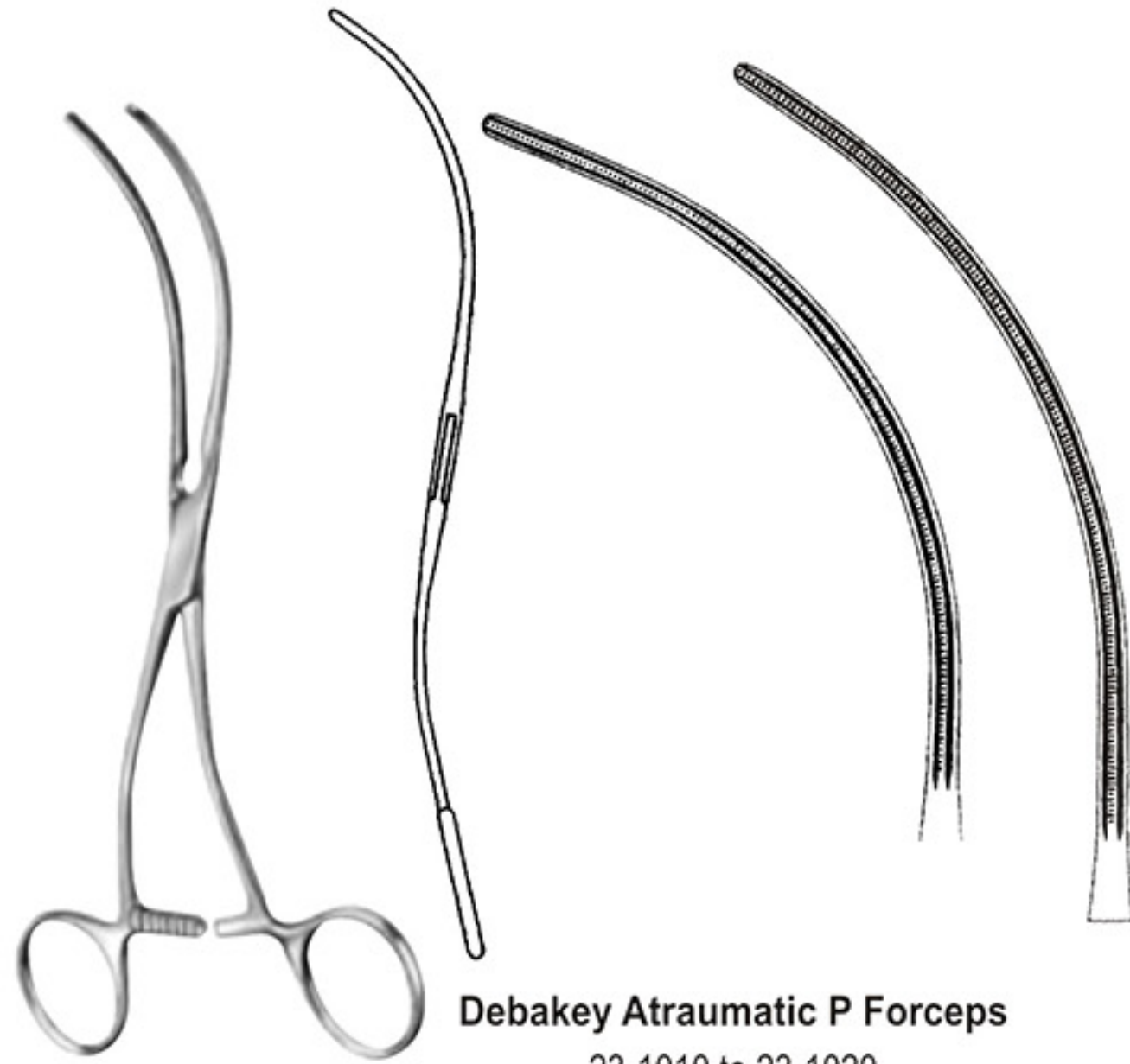

Debakey Atraumatic P Forceps

23-1010 to 23-1020

- | | |
|-------------------------------|------------------------------------|
| 23-1011-7.50" Straight (A) | 23-1016-8.25" Straight Coarctation |
| 23-1012-7.50" Angle 15°(B) | 23-1017-8.25" Angle Patent |
| 23-1013-7.50" Angle 30°(C) | 23-1018-8.25" Angle Coarctation |
| 23-1014-6.00" Full Curved | 23-1019-7.25" Vessel Forceps |
| 23-1015-8.25" Straight Patent | 23-1020-8.00" Vessel Forceps |

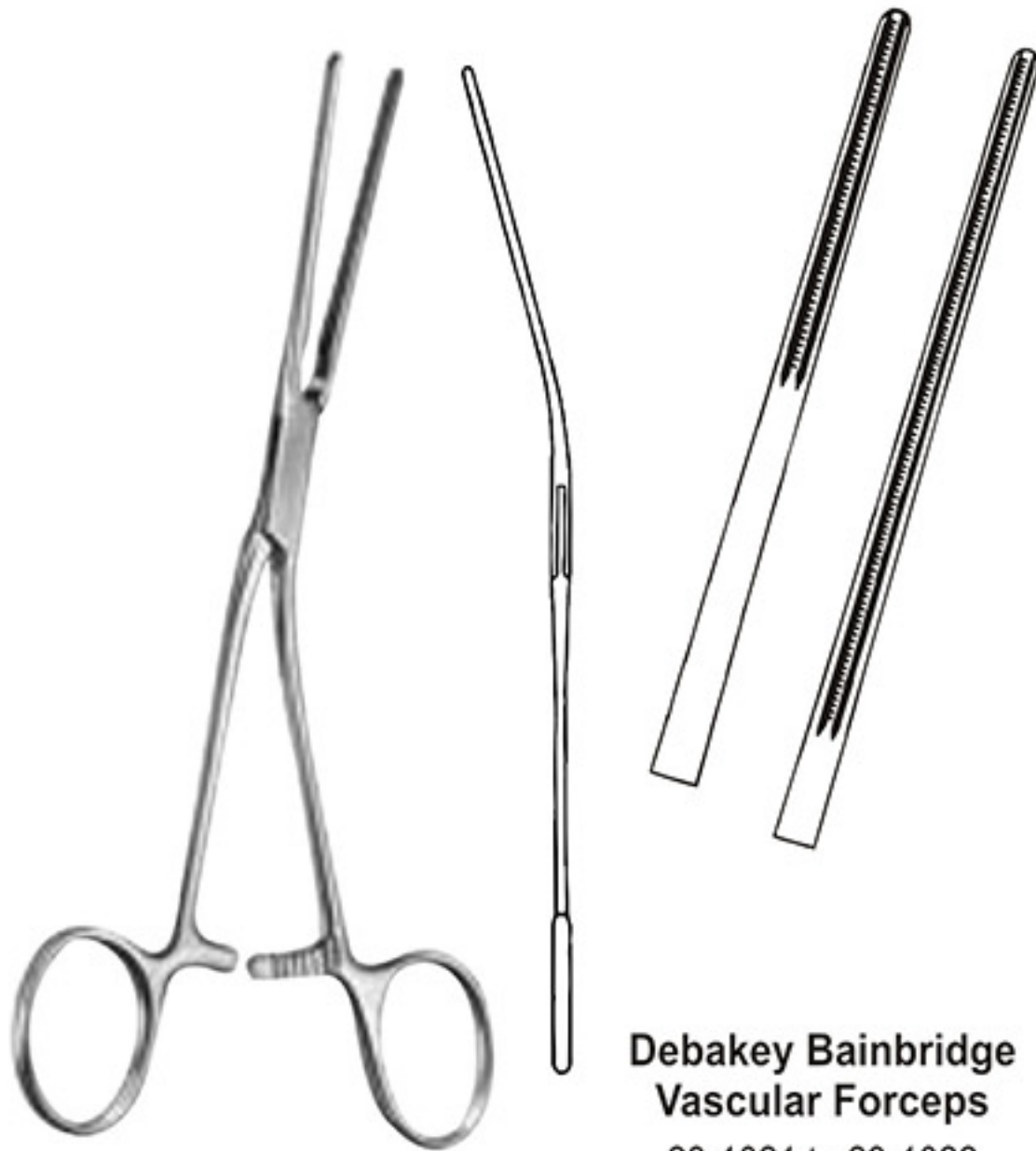

Debakey Bainbridge Vascular Forceps

23-1021 to 23-1022

- 23-1021-8.25" Patent Ductus Angular
- 23-1022-8.25" Coarctation Angular

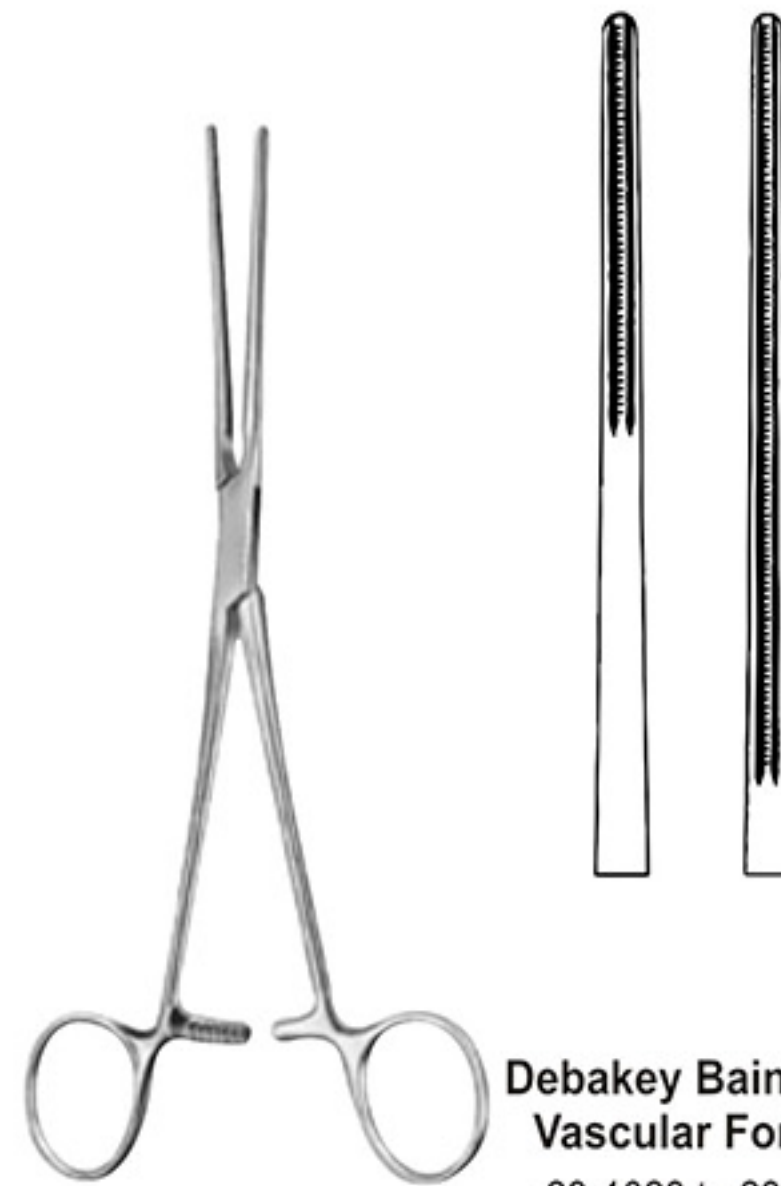

Debakey Bainbridge Vascular Forceps

23-1023 to 23-1024

- 23-1023-8.25" Patent Ductus Straight
- 23-1024-8.25" Coarctation Straight



Peet Splinter Forceps
24-1053

24-1053- 4.75" str.
24-1053A-4.75" 45°
24-1053B-4.75" 90°



Peers Towel Clamps
24-1054

24-1054-5.75"



Pratt Smith "T" Forceps
24-1055

24-1055-6.00"



Kelly Placenta Forceps
24-1056

24-1056-12.00"



Bauer Sponge Forceps
24-1057 to 24-1058

24-1057-9.50" Straight
24-1058-9.50" Curved



Thumb Dressing Forceps

25-601 to 25-612



Thumb Tissue Forceps

25-614 to 25-621



Thumb Tissue Forceps

25-622-5.00" 2x3
25-623-5.50" 2x3
25-625-5.00" 3x4
25-627-5.50" 3x4



Semkin Dressing / Tissue Forceps

25-624 to 25-626

25-624-5.50"
25-626-5.50" 1x2



Russian Tissue Forceps

25-628 to 25-629

25-628-6.00"
25-629-8.00"



College Plier

25-630 to 25-631

25-630-Str.
25-631-Cvd.



College Plier with Lock

25-632 to 25-633

25-632-W Lock Str.
25-633-W Lock Cvd.



Feilchenfeld Splinter Forceps

25-634 to 25-636

25-634-3.50"
25-636-4.50"



Adson Forceps

25-640 to 25-650

25-640-4.75" Serrated
25-642-4.75" Serrated Micro
25-644-4.75" Tissue 1/2
25-646-4.75" Tissue 1/2 Micro
25-648-4.75" Brown 7x7
25-650-4.75" Brown 9x9



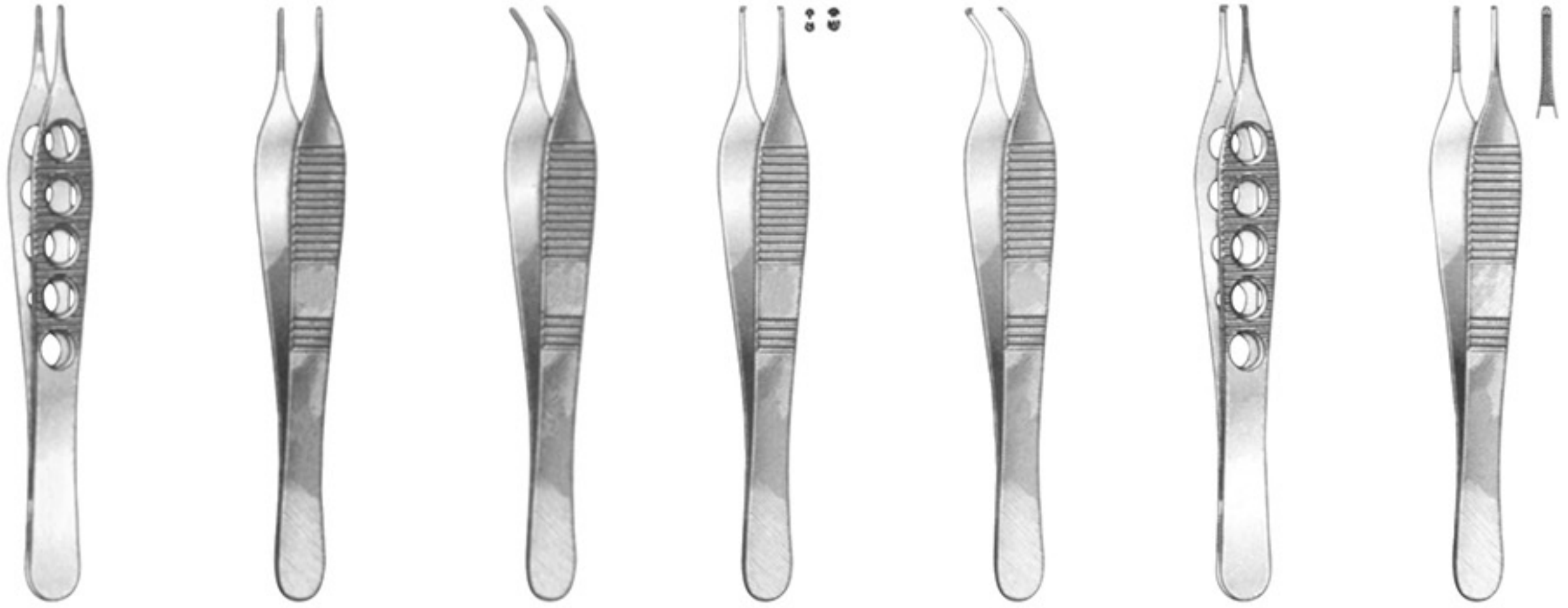

Adson Dressing Forceps 25A-642F	Adson Dressing Forceps 25A-642PM	Adson Dressing Forceps 25A-642PAM	Adson Tissue Forceps 25A-646P	Adson Tissue Forceps 25A-646PA	Adson Tissue Forceps 25A-646F	Adson Tissue Forceps 25A-644PS
25A-642F-4.3/4" serrated fenestrated	25A-642PM-4.3/4" serrated, delicate w/platform	25A-642PAM-4.3/4" serrated, delicate angled platform	25A-646P-4.3/4" 1 x 2 teeth, delicate platform	25A-646PA-4.3/4" 1 x 2 teeth, delicate, angled platform	25A-646F-4.3/4" 1 x 2 teeth, lightweight, fenestrated handles	25A-644PS-4.3/4" 1 x 2 teeth, & Cross serrated tips, delicate



Adson Tissue & Suture Forceps 25A-646PTP	Adson Brown Tissue & Suture Forceps 25A-646FTP	Brown-Adson Tissue Forceps 25A-648A	Brown-Adson Tissue Forceps 25A-648P	Brown-Adson Tissue Forceps 25A-648F	DeBakey-Adson Tissue Forceps 25A-640D
25A-646PTP-4.3/4" 1 x 2 teeth with tying platform	25A-646FTP-4.3/4" w-platform, 1 x 2 teeth lightweight, fenestrated handles	25A-648A-4.3/4" 7 x 7 side grasping teeth, angular	25A-648P-4.3/4" 7 x 7 grasping teeth	25A-648F-4.3/4" 7 x 7 side grasping teeth, lightweight, fenestrated handles	25A-640D-4.3/4" atraumatic tips 1.5mm wide

A TRADITION OF QUALITY A PROMISE OF VALUE.

Wild Ear Forceps

26-652 to 26-654

 26-652-4.75"
 26-654-5.00"

Adson Bayonet Forceps

26-655 to 26-658

 26-655-5.1/2"
 26-656-6.25"
 26-657-8"

Eye Dressing Forceps

26-660 to 26-664

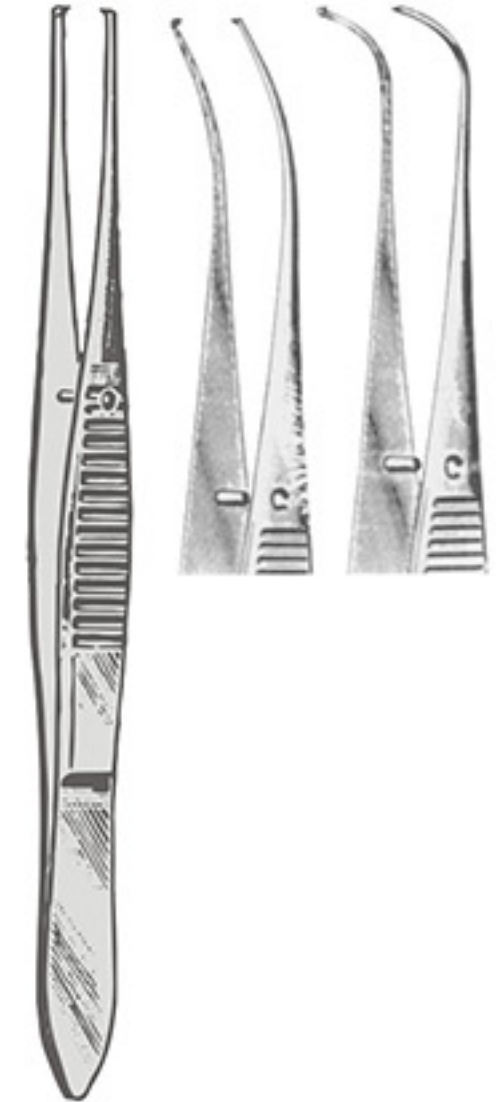
 26-660-4.00" Straight
 26-662-4.00" Half Curved
 26-664-4.00" Full Curved

Eye Tissue Forceps

26-666 to 26-670

 26-666-4.00" Straight 1x2
 26-668-4.00" Half Curved 1x2
 26-670-4.00" Full Curved

Splinter Forceps

26-672 to 26-677

 26-672-3.5"
 26-674-4.5"
 26-675-4.5" cvd.
 26-677-5"

Carmalt Splinter

26-676 to 26-678

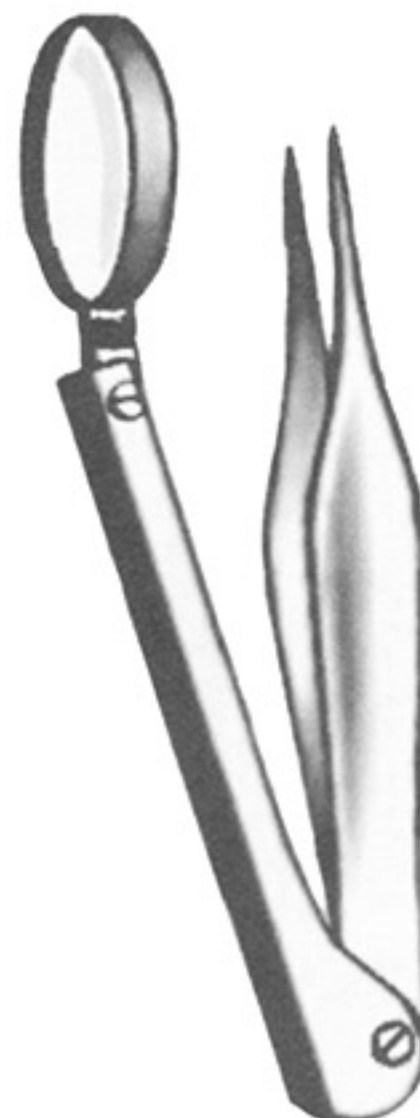
 26-676-4.75" Straight
 26-678-4.75" Curved

Plain Splinter Forceps

26-684

26-684 with Magnifier

Lane Tissue Forceps

26-685 to 26-686

 26-685-5.00" 1x2
 26-686-7.50" 1x2

Michel Tissue Forceps

26-687

26-687-5.00" 1x2 Teeth



Stille Tissue Forceps
27-688

27-688-5.00" 4x5



Essring Tissue Forceps
27-689

27-689-6.00" Angular



Tissue Forceps
27-690

27-690-9.25" 1x2 Curved



Tuttle / Singley Forceps
27-691 to 27-692

27-691-7.00"
27-692-9.00"



Brown Tissue Forceps
27-693 to 27-695

27-693- 6.00" Side Grasping
27-694- 9.00" Side Grasping
27-695-10.00" Side Grasping



Bonney Tissue Forceps
27-696

27-669-7.00" 1x2 Teeth



King Forceps
27-697

27-697-5.50"



Bishop Hartman tissue Forceps
27-698 to 27-699

27-698-3.50" Serrated
27-699-3.50" 1x2 Teeth
27-698-3.50" M Micro serrated
27-699-3.50" M Micro 1 x 2 Teeth



Ferris Smith Forceps
27-700

27-700- 7.00" 1x2
27-700A-7.00" 2x3

A TRADITION OF QUALITY A PROMISE OF VALUE.

Probe with Eye
 28-702 to 28-706

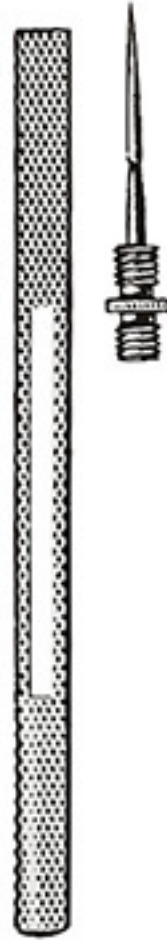
 28-702-5.00" 28-703-7.00"
 28-704-5.50" 28-705-8.00"
 28-706-6.00"

Splinter Liberatot Trocar Point
 28-707

28-707-5.00"

Double Ended Probe
 28-708 to 28-713

 28-708-5.00"
 28-710-5.50"
 28-712-6.00"
 28-713-7.00"

Grooved Director
 28-714 to 28-717

 28-714-5.00" W/Tung Tie
 28-716-5.50" W/Tung Tie
 28-717-6.00" W/Tung Tie

Grooved Director
 28-718 to 28-721

 28-718-5.00" W/Eye
 28-720-5.50" W/Eye
 28-721-6.00" W/Eye

Pomery Ear Syringe all Metal
 28-740 to 28-744

 28-740-2-Oz.
 28-742-3-Oz.
 28-744-4-Oz.

Tuning Fork Complete Box Set of 5 Pcs.

28-866 / C Set

Aluminum Alloy Tuning Fork

 28-866-C128
 28-866-C256
 28-866-C512
 28-866-C1024
 28-866-C2048

Tuning Fork W / Buck Hammer and Pin Wheel (5 Items)

28-867

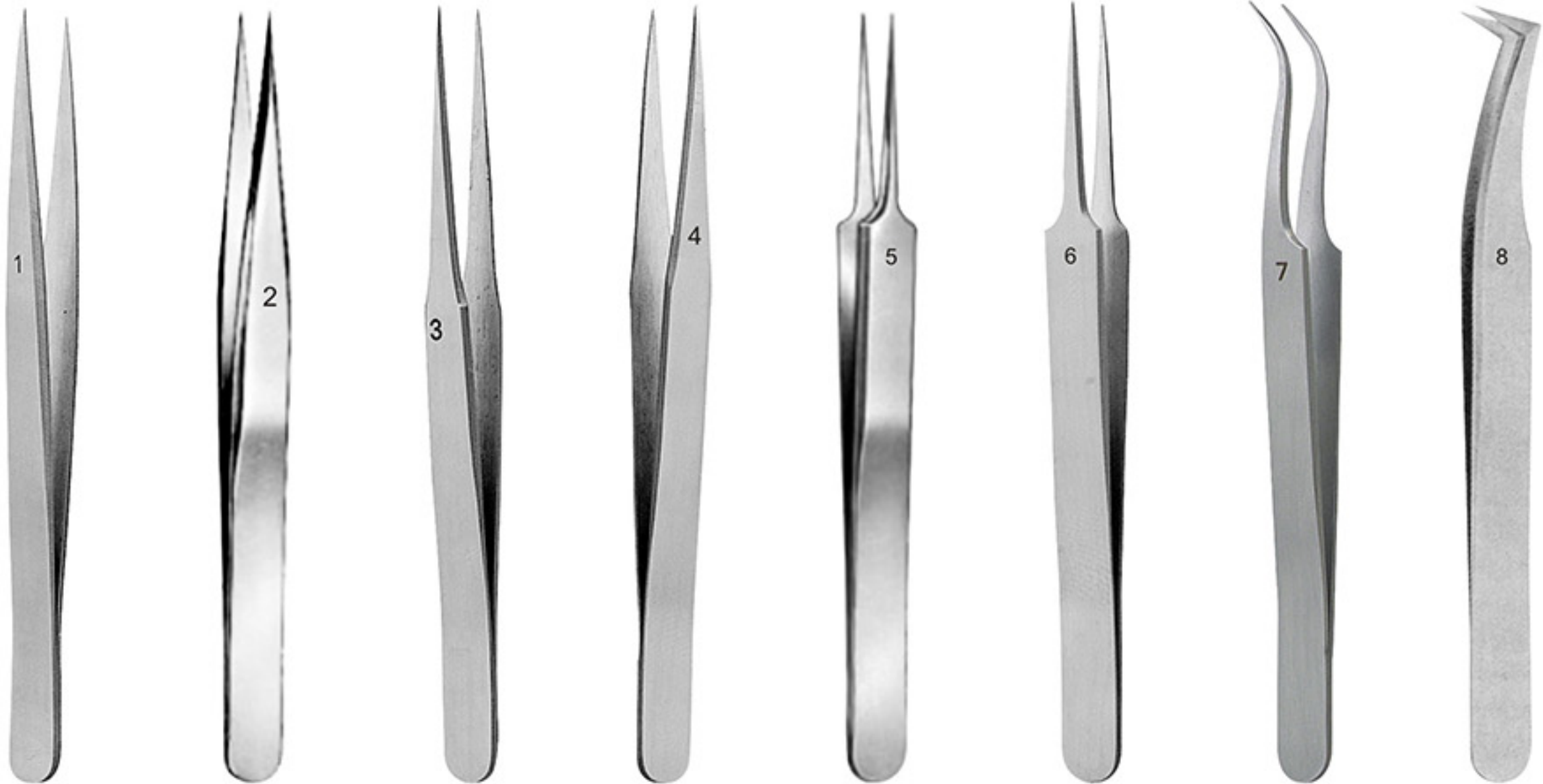

Jewelers Forceps	Jewelers Forceps	Jewelers Forceps	Jewelers Forceps	Jewelers Forceps	Jewelers Forceps	Jewelers Forceps	Jewelers Forceps
29-902-1	29-902-2	29-902-3	29-902-4	29-902-5	29-902-6	29-902-7	29-902-8

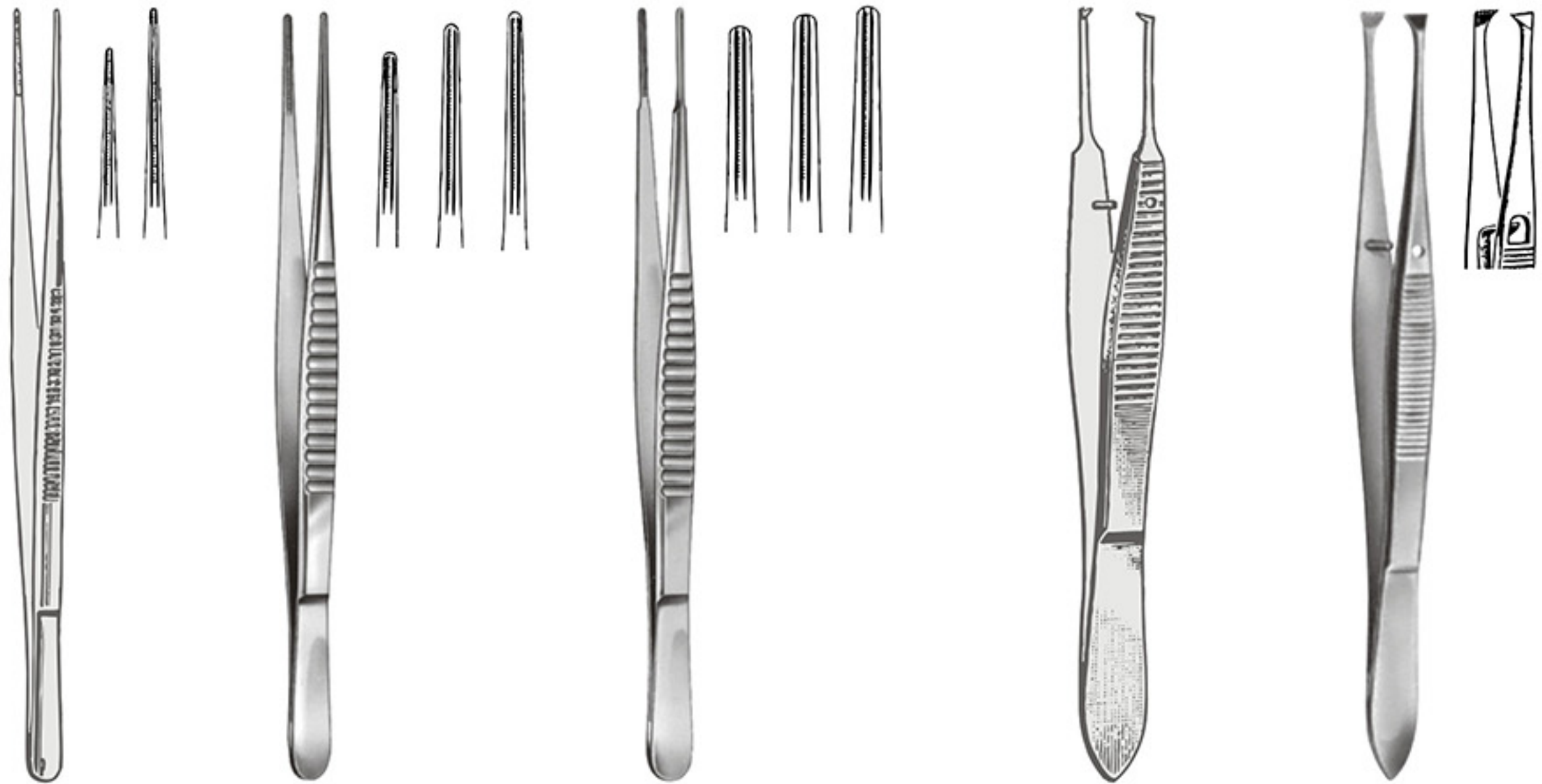

Debakey Atraumatic Tissue 29-1025 to 29-1027	Debakey Atraumatic Tissue 29-1028 to 29-1030	Debakey Atraumatic Tissue Forceps 29-1031 to 29-1033	Graefe Iris Forceps 29-1034 to 29-1035	Graefe Fixation 29-1036 to 29-1037
29-1025-6.25" 1.5mm Jaws 29-1026-7.75" 1.5mm Jaws 29-1027-9.50" 1.5mm Jaws	29-1028-6.25" 1.5mm Jaws 29-1029-7.75" 1.5mm Jaws 29-1030-9.50" 1.5mm Jaws	29-1031-6.25" 2.0mm Jaws 29-1032-7.75" 2.0mm Jaws 29-1033-9.50" 2.0mm Jaws	29-1034-2.75" Straight 1/2 Teeth 29-1035-2.75" Full Curved 1/2 Teeth	29-1036-4.00" Without Lock 29-1037-4.00" With Lock

A TRADITION OF QUALITY A PROMISE OF VALUE.

Castroviejo Forceps
 30-1038 to 30-1039

 30-1038-5.00"
 W/Platform 0.5mm
 30-1039-5.00"
 W/Platform 0.9mm

Cushing Forceps
 30-1040

 30-1040-7.00"
 Serrated

Cushing Forceps
 30-1041

 30-1041-7.00"
 1x2 Teeth

Gerald Dressing Forceps
 30-1042

 30-1042-7.00"
 Serrated Tips,

Gerald Tissue Forceps
 30-1043

 30-1043-7.00"
 1x2 Teeth

DeBakey Bulldog Clamp
 30-1044 to 30-1049

 30-1044- 3.00" Bulldog Vascular Clap, Straight
 30-1045- 3.50" Bulldog Vascular Clap, Straight
 30-1046- 4.25" Bulldog Vascular Clap, Straight
 30-1047- 3.00" Bulldog Vascular Clap, Cross Action
 30-1048- 3.50" Bulldog Vascular Clap, Cross Action
 30-1049- 4.25" Bulldog Vascular Clap, Cross Action

Bergh Cilia Forceps
 30-1050

30-1050-3 1/2"

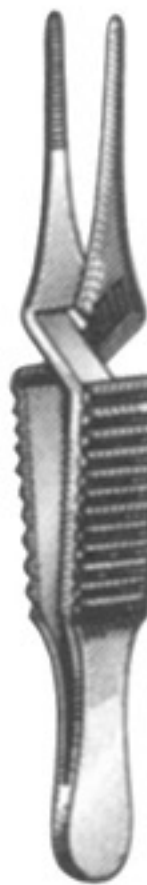
Diethrich Micro Bulldog Clamp
 30-1052M

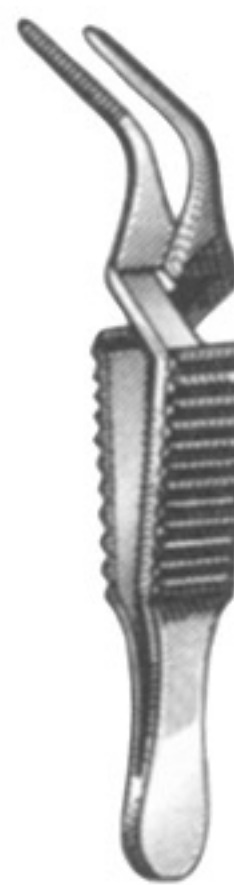
 30-1052M-1 7/8"
 Straight Jaws
 8mm x 1.2mm

Diethrich Micro Bulldog Clamp
 30-1053M

 30-1053M-1 7/8"
 angled Jaws
 8mm x 1.2mm

Littauer Cilia Forceps
 30-1051

30-1051-3 1/2"

Johns Hopkins Bulldog Clamp
 30-1052

Johns Hopkins Bulldog Clamp
 30-1053



Whitehead Gag
31-1256 to 31-1258

Whitehead Gag
31-1259 to 31-1261

Seemann-Seiffert
31-1256A to 31-1258A

- 31-1256-4.25"
- 31-1257-5.25"
- 31-1258-6.00"

- 31-1259-4.25"
- 31-1260-5.25"
- 31-1261-6.00"

- 31-1262- 3.50"
- 31-1263- 4.25"
- 31-1264- 5.25"

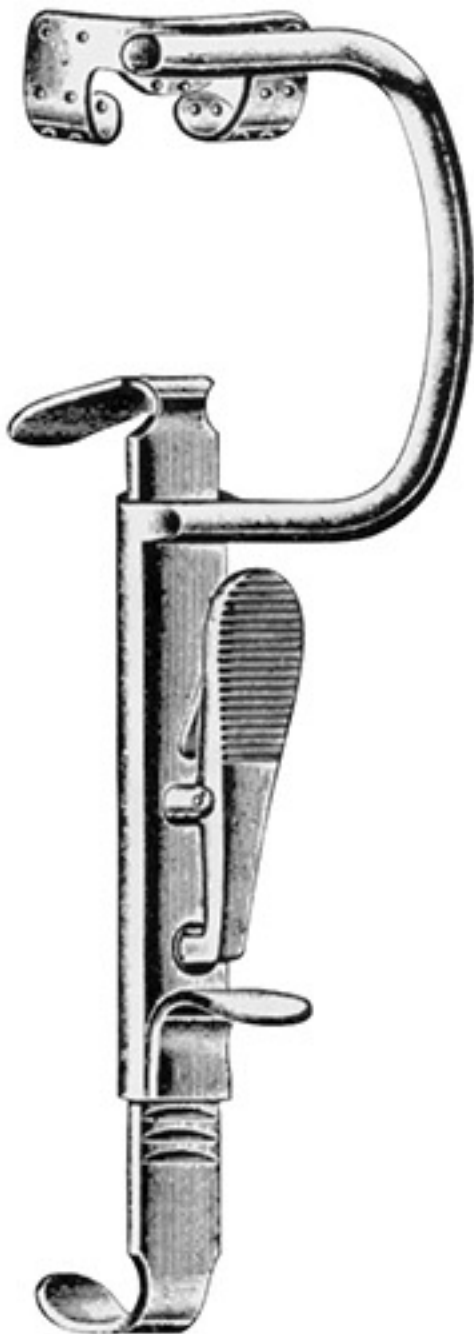

Davis Boyle (Mouth Gag)
31-1265

Davis Boyle (Blades)
31-1266 to 31-1270

31-1267
25x90mm Fig. 2

31-1268
25x75mm Fig. 3

31-1269
22x60mm Fig. 4

- 31-1266-27x105mm
- 31-1267-25x 90mm
- 31-1268-25x 75mm
- 31-1269-22x 60mm
- 31-1270-20x 25mm

A TRADITION OF QUALITY A PROMISE OF VALUE.

Farrell Applicator
 32-1383 to 32-1385

 32-1383 - 6.50"
 32-1384 - 6.00"
 32-1385 - 9.00"

Buck Applicator
 32-1386

32-1386 - 7.50"

Buck Applicator
 32-1387

32-1387 - 5.00"

Window Punch
 32-1088

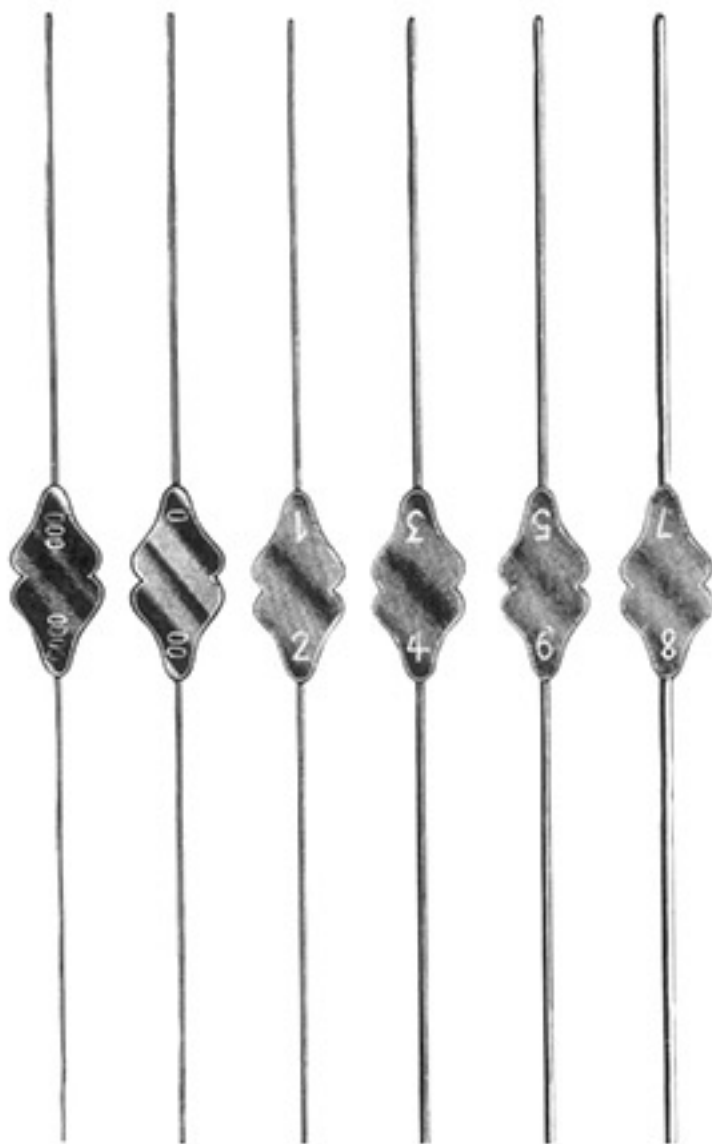
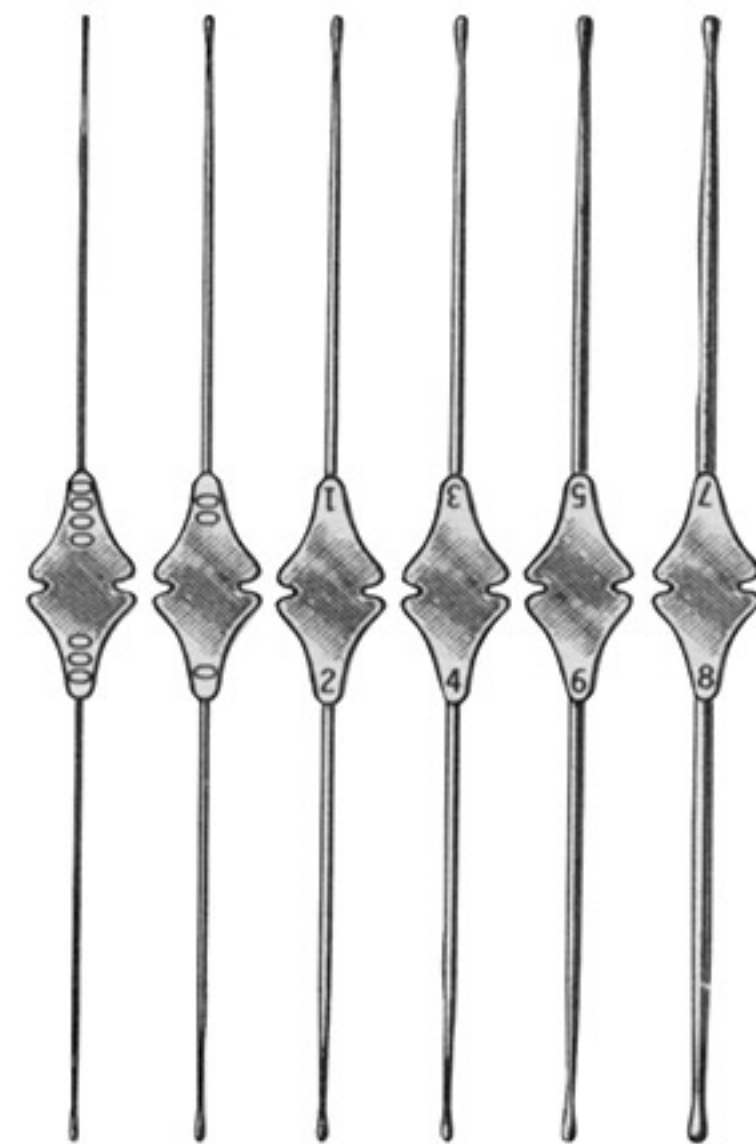
Pen Light With Different Color
 32-1089

Bowman Lacrimal Probes
 32-1090 to 32-1095

William Lacrimal Probes
 32-1090w to 32-1095w

32-1090 Bowman Probe, 000-0000, Double Ended, Sterling Silver	
32-1091 Bowman Probe, 00-0, Double Ended, Sterling Silver	
32-1092 Bowman Probe, 1-2, Double Ended, Sterling Silver	
32-1093 Bowman Probe, 3-4, Double Ended, Sterling Silver	
32-1094 Bowman Probe, 5-6, Double Ended, Sterling Silver	
32-1095 Bowman Probe, 7-8, Double Ended, Sterling Silver	

32-1090w William Probe, 000-0000, Double Ended, Sterling Silver	
32-1091w William Probe, 00-0, Double Ended, Sterling Silver	
32-1092w William Probe, 1-2, Double Ended, Sterling Silver	
32-1093w William Probe, 3-4, Double Ended, Sterling Silver	
32-1094w William Probe, 5-6, Double Ended, Sterling Silver	
32-1095w William Probe, 7-8, Double Ended, Sterling Silver	



Vienna Nasal Speculum
33-735 to 33-738

33-735 - Infant
33-736 - Child
33-738 - Adult

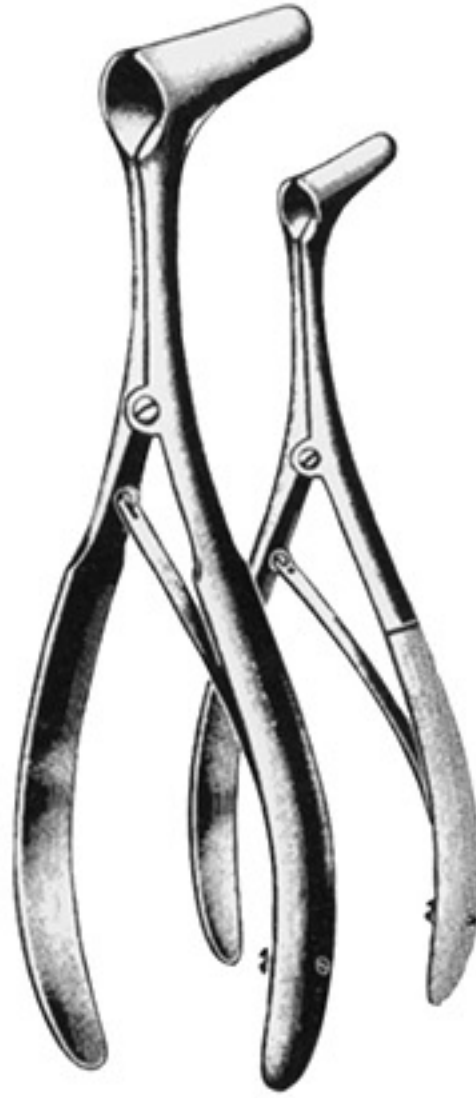

Halle Nasal Speculum
33-1208 to 33-1209

33-1208 - Infant
33-1209 - Adult



Vienna Nasal Speculum
33-1210

33-1210 - Adult



Cottle Septal Speculum
33-1211 to 33-1214

33-1211 - 6.00" 1.20" Blade
33-1212 - 6.00" 2.00" Blade
33-1213 - 6.00" 3.00" Blade
33-1214 - 6.00" 3.50" Blade

Killian Nasal Speculum
33-1215 to 33-1217

33-1215 - 2.00" Small
33-1216 - 3.00" Medium

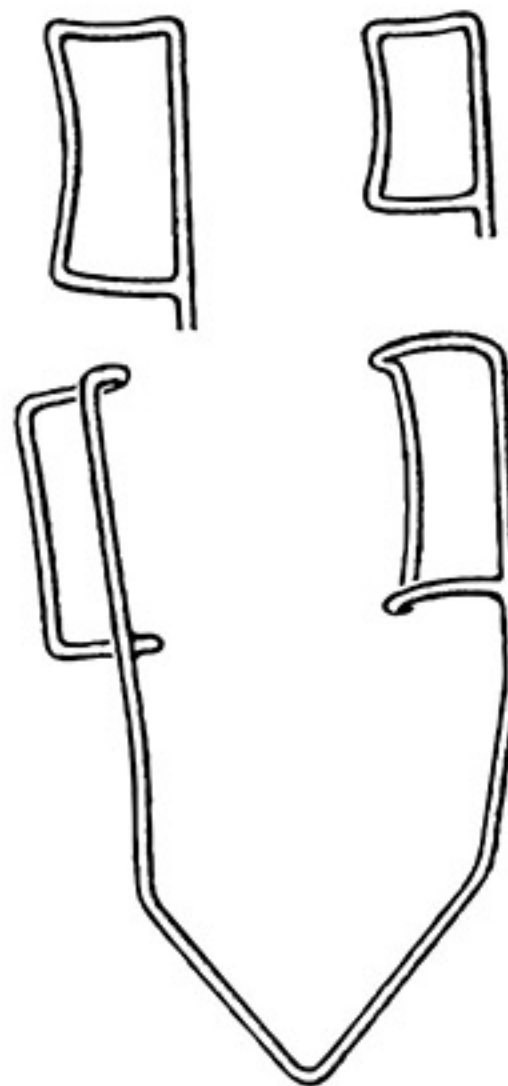

Barraquer Eye Speculum
33-1218 to 33-1222

33-1218 - Child 10mm Loop
33-1219 - Adult 15mm Loop
33-1220 - Heavy Adult 15mm Loop
33-1221 - Infant 8mm Loop
33-1222 - Infant 4mm Loop

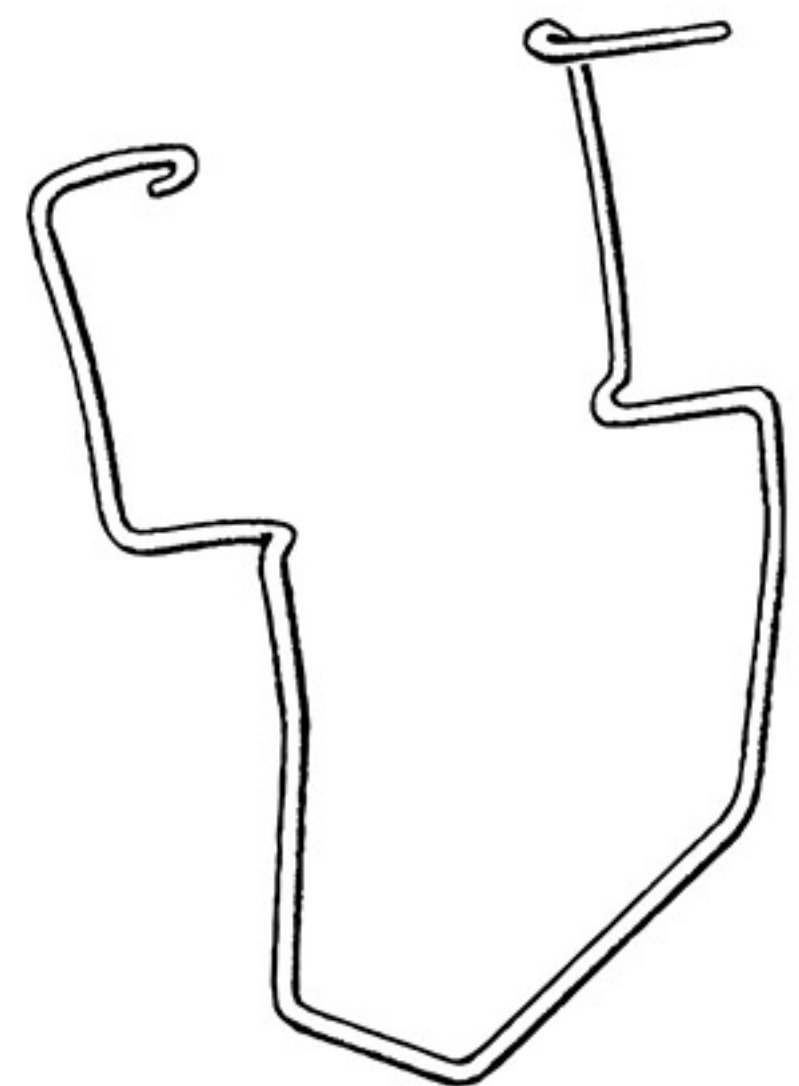

Kratz-Barraquer Eye Speculum
33-1223 to 33-1225

33-1223 - infant 12mm Blade
33-1224 - Child 15mm Blade
33-1225 - Adult 18mm Blade

A TRADITION OF QUALITY A PROMISE OF VALUE.

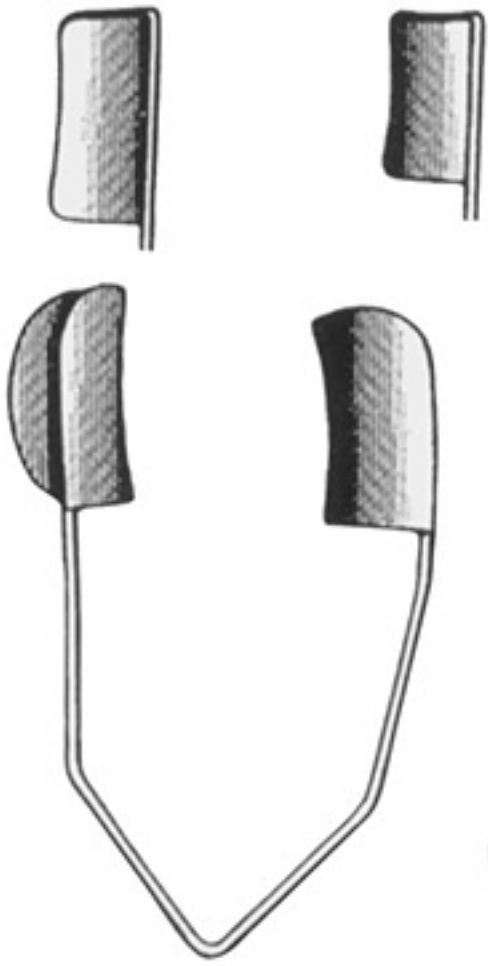

Barraquer Wire Speculum

34-1226 to 34-1227

 34-1226 - Child 10mm Solid Blade
 33-1227 - Adult 15mm Solid Blade

Cook Eye Speculum

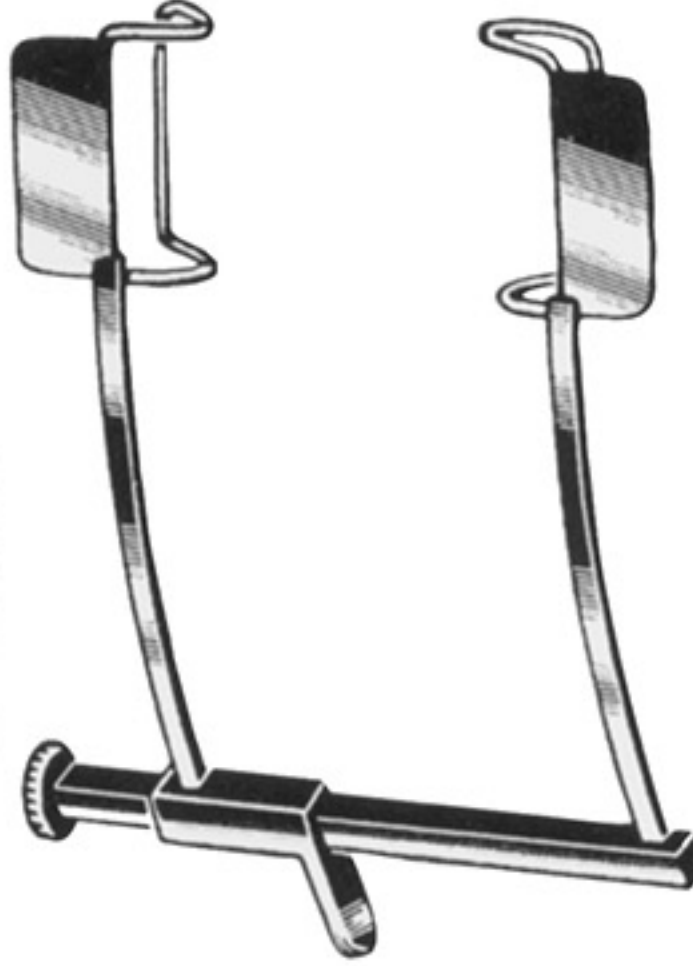
34-1228 to 34-1229

 34-1228 - 9x3mm Solid Blade
 Spread 25mm infant
 34-1229 - 11x13mm Solid Blade
 Spread 27mm Adult

Wiener Eye Speculum

34-1230

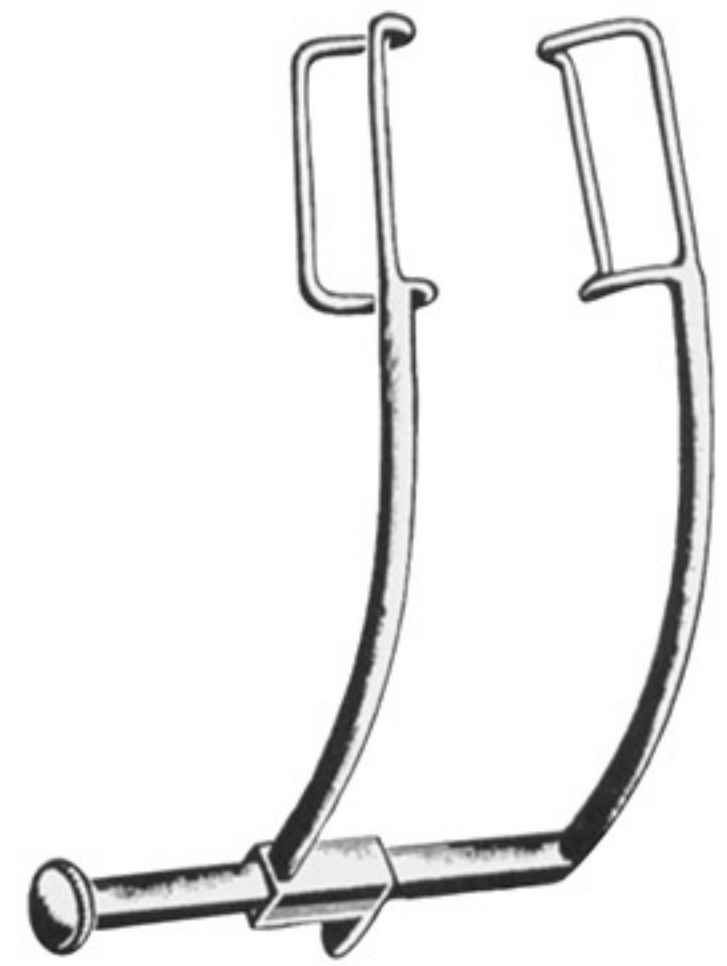
34-1230 - 2.25" 15mm Blade

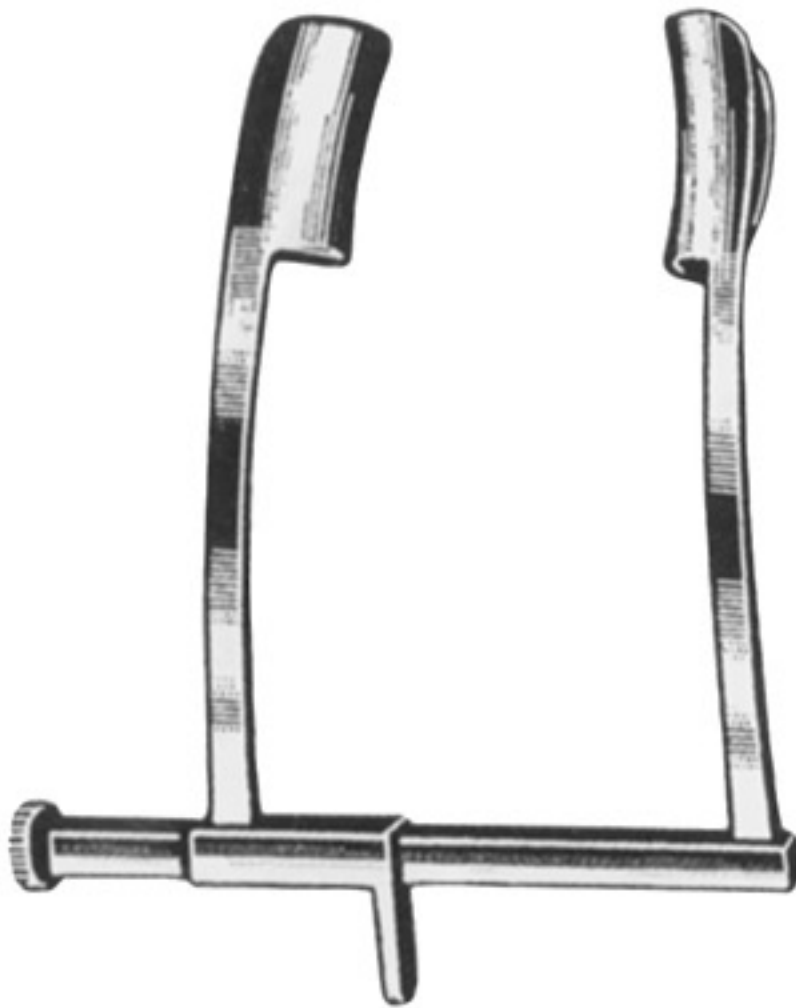

Murdock Eye Speculum

34-1231

 34-1231 - 2.00" 14mm Blade
 Spread 23mm

McKinney Eye Speculum

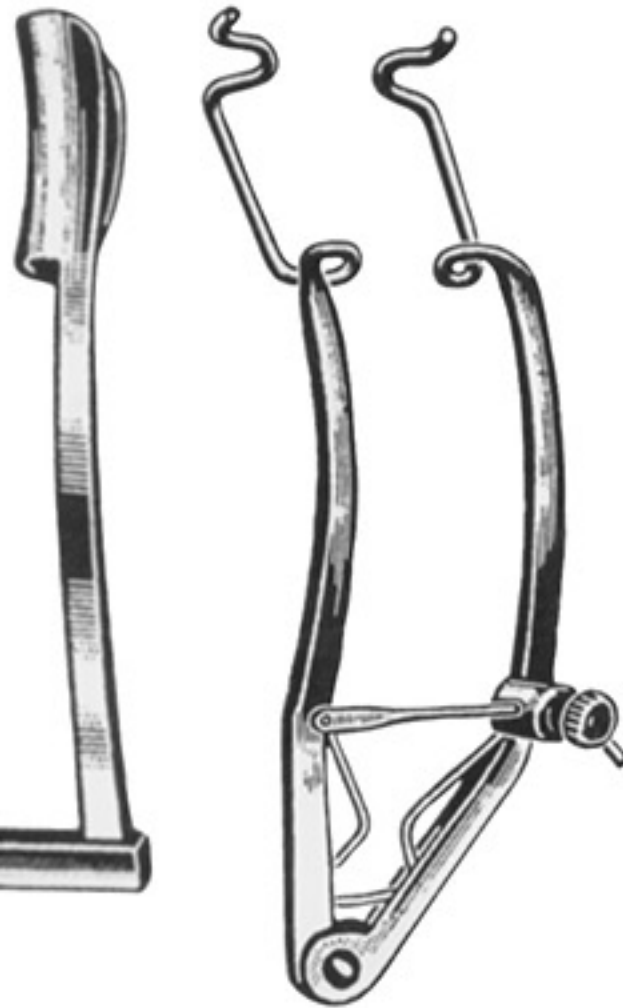
34-1232

34-1232 - 2.00" 15mm Blade



Knapp Eye Speculum

34-1233

34-1233 - Non-Magnetic

McPherson Eye Speculum

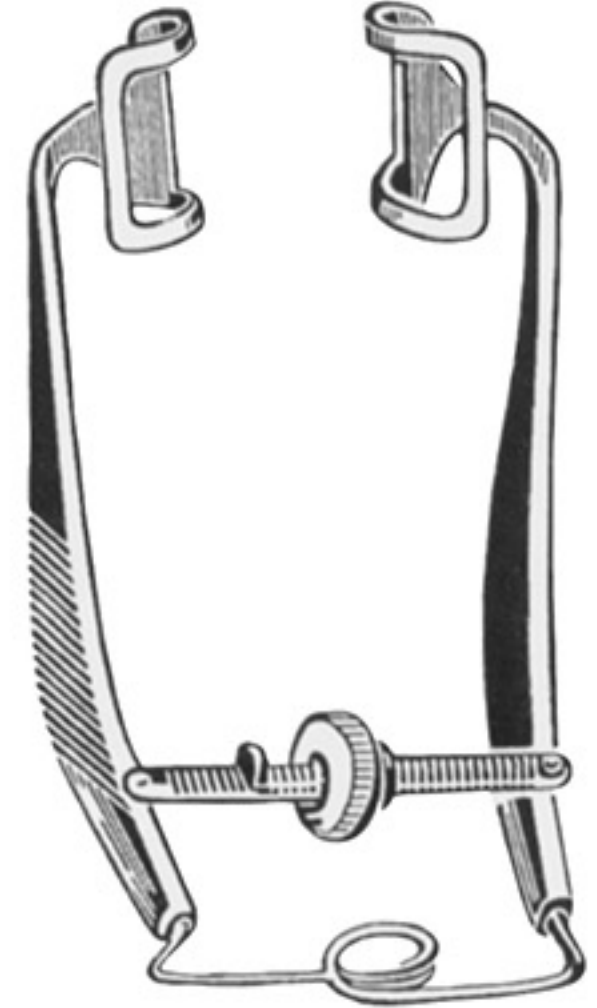
34-1234

 34-1234 - Blade 27mm
 Wide with Suture Posts

Ziegler Speculum

34-1235

34-1235 - 2.25"



Mellinger Speculum
35-1236

35-1236 - 2.75" Adult



Saure Eye Speculum
35-1237

35-1237 - 1.25" Infant 10mm

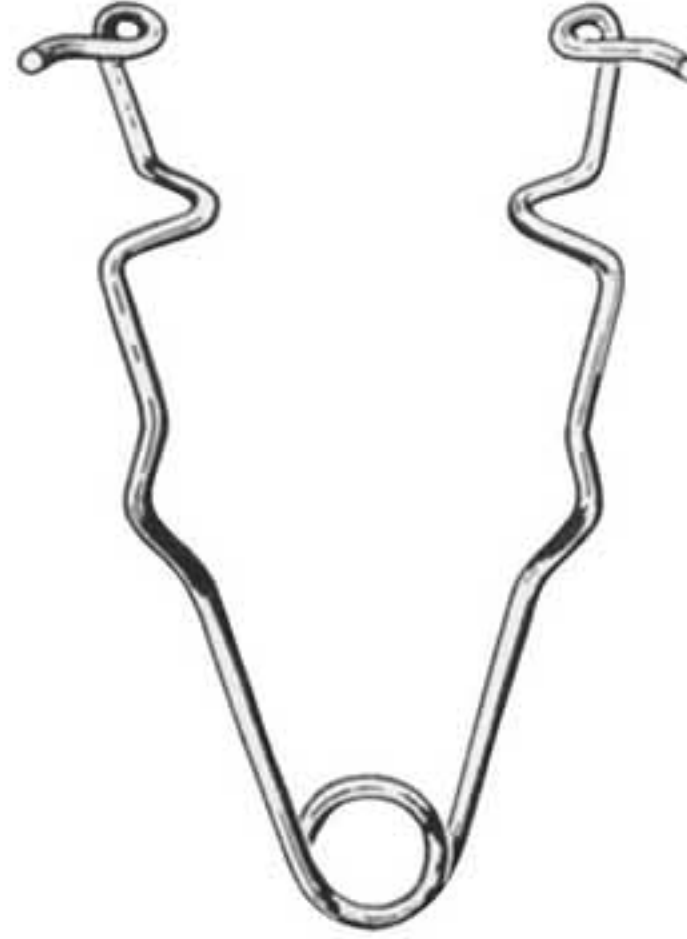

Plain Wire Speculum
35-1238 to 35-1239

35-1238 - 2.00" Child
35-1239 - 2.75" Adult



Park Maumenee Eye Speculum
35-1240

35-1240 - Non Magnetic Guard over Locking Screw

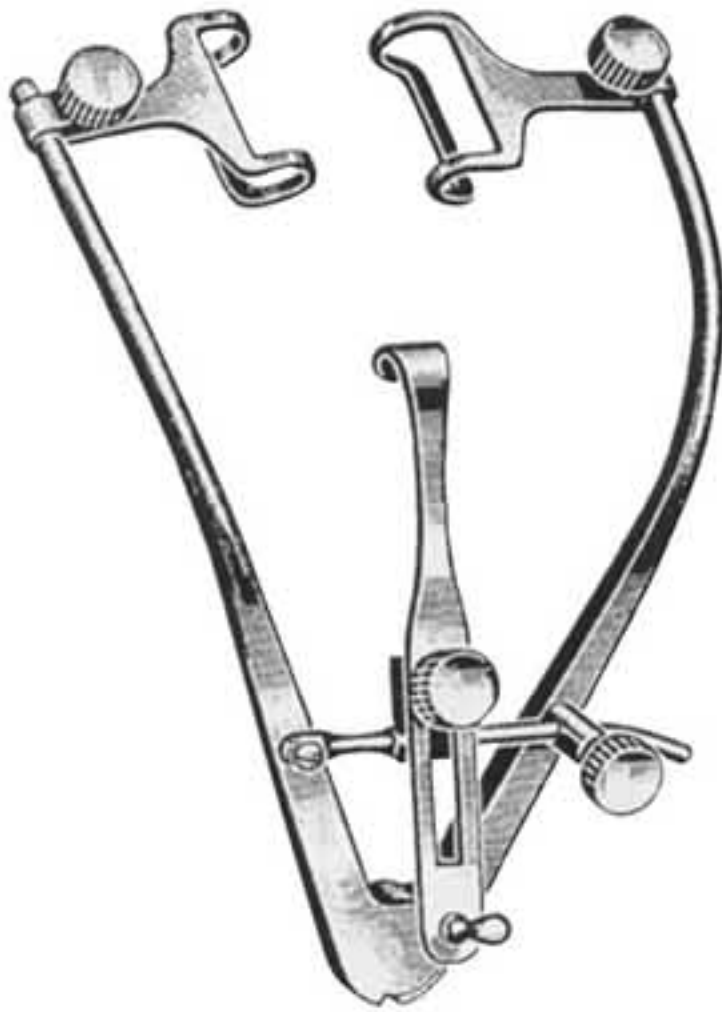

Park Guyton Eye Speculum
35-1241

35-1241 - 3.00' Length



Castroviejo Speculum
35-1242

35-1242 - 3.50"

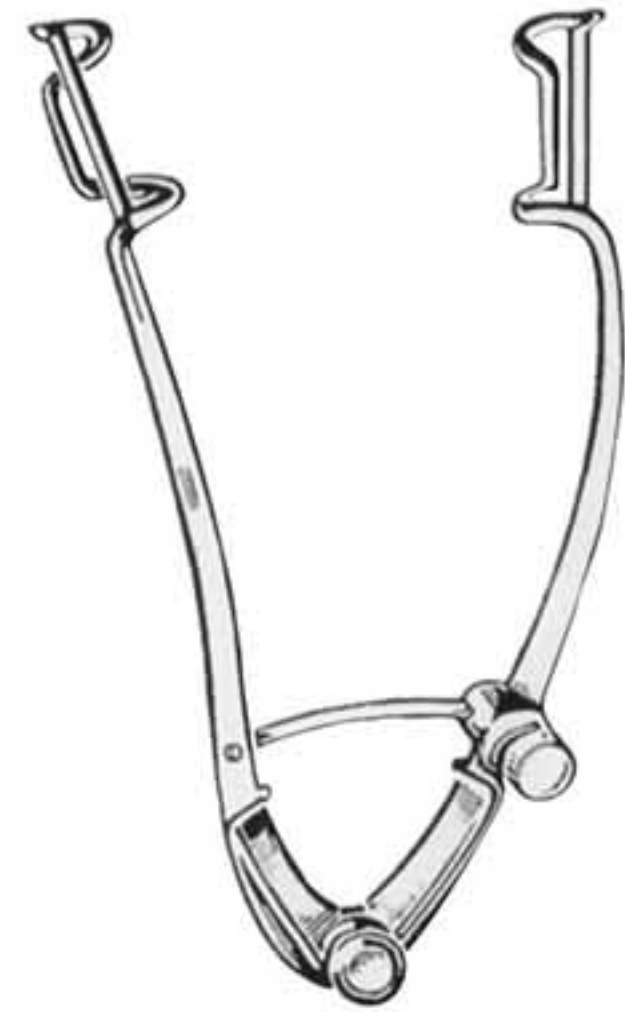

Williams Speculum
35-1243 to 35-1244

35-1243 - 2.75" Child
35-1244 - 2.75" Adult



Weeks Eye Speculum
36-1245

36-1245 - 3.25" Long 15x15mm Loop



Lancaster Eye Speculum
36-1246 to 36-1247

36-1246 - Non Magnetic
36-1247 - Standard Pattern



Muller Retractor
36-1248

36-1248-3.00"

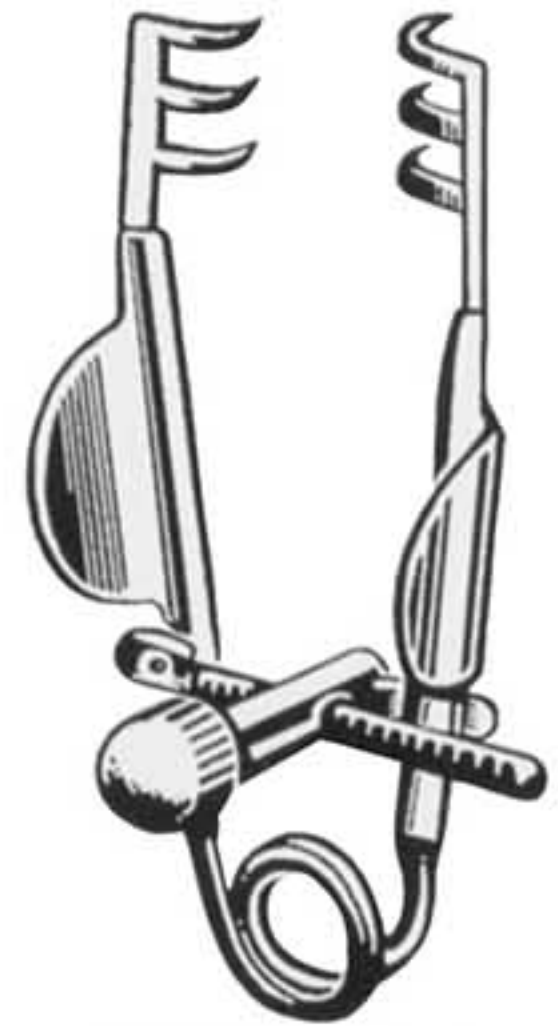

Self-Retaing Retractor
36-1249

36-1249-1.50" Delecate



Goldstein Retractor
36-1250

36-1250-1.00"



Stevenson Retractor
36-1251

36-1251-3.00"



Wilder Self-Retaing
36-1252

36-1252-2.25" 2x2 Prong Sharp
2mm Deep



Jennings Mouth Gag
36-1253 to 36-1255

36-1253-Small 4 1/2"
36-1254-Child 5.00"
36-1255-Large 5 1/2"



Doyen-Jansen Mouth Gag
37-1271 to 37-1273

- 37-1271 - With Rubber Sleeves
- 37-1272 - Rubber Sleeves only
- 37-1273 - Pediatric-Complete



Desmarres Lid Retractor
37-1274 to 37-1277

- 37-1274 - #1 5.50"
- 37-1275 - #2 5.50"
- 37-1276 - #3 5.50"
- 37-1277 - #4 5.50"



Graefe Cataract Knives
37-1278 to 37-1280

- 37-1278 - Small Blade 1.7mm x 27mm
- 37-1279 - Small Blade 2.0mm x 30mm
- 37-1280 - Small Blade 2.3mm x 33mm

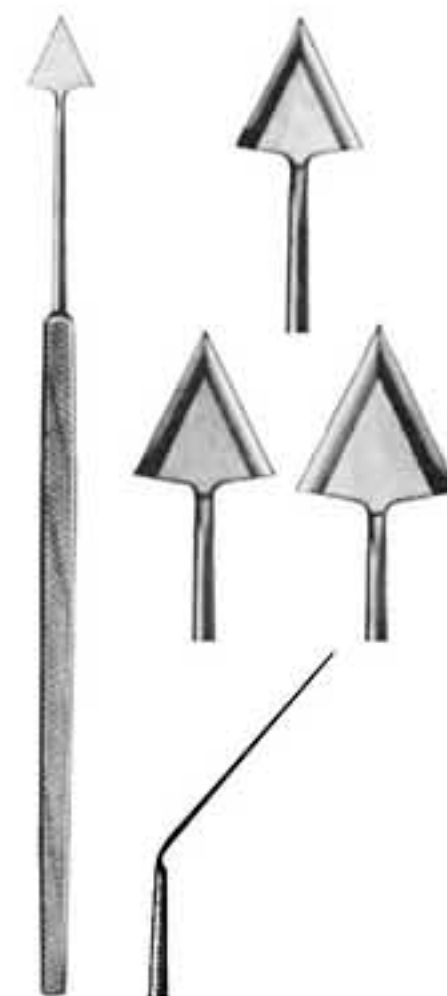

Grieshaber Type Keratomes
37-1281 to 37-1284

- 37-1281 - Extra Small Size 0
- 37-1282 - Small Size 1
- 37-1283 - Medium Size 2
- 37-1284 - Large Size 3



Jaeger Keratomes
37-1285 to 37-1288

- | | | |
|------------------------------|------------|---------------|
| 37-1285 - Extra Small Size 0 | 8.0 x 9.5" | Angular Blade |
| 37-1286 - Small Size 1 | 9.5 x 11" | Angular Blade |
| 37-1287 - Medium Size 2 | 11 x 2.50" | Angular Blade |
| 37-1288 - Large Size 3 | 12 x 14" | Angular Blade |



Castroviejo Keratome
37-1289

- 37-1289
13 x 4mm



Berens Keratome
37-1290

- 37-1290
19 x 3.25mm



Bailey Foreign Body Remover
37-1291

- 37-1291
Reversible Handle Chrome Plated



**Junior Magnetic Probe
Body Loop**
37-1292

- 37-1292 - reversible Handle



**Junior Magnetic Probe
Body Loop**
38-1293

38-1293-W/Magnifier



**Ellis Foreign
Body Spud**
38-1294

38-1294-4.50" 1.2mm
Blade Curved



**Alvis Foreign
Body Spud**
38-1295

38-1295-4.75" 1.0mm x 3.0mm
Oval Curette W/Fine Point



**Foreign Body
Needle**
38-1296

38-1296-Straight / Curved



**Troutman Blade
Breaker**
38-1297

38-1297-10cm



**Barraquer Blade
Breaker**
38-1298

38-1298-10.5cm



**Castroveijo Blade
Breaker**
38-1299

38-1299-10cm



**Castroviejo
Cyclodilysis**
38-1300 to 38-1302

38-1300-Spatulas D/Ended
15mm Length 0.5mm wide
38-1301-Spatulas D/Ended
15mm Length 0.75mm wide
38-1302-Spatulas D/Ended
15mm Length 1.0mm wide



**Barraquer Cyclodilysis
Spatulas**
38-1303

38-1303-12cm .50mm
Diameter Round 15mm Angle



**Elschnig Cyclodialysis
Spatulas**
38-1304

38-1304-13cm
10mm x 1mm



Green Spatulas

38-1305

38-1305-6.00"
Slightly Curved



Bunge Evisceration Spoons
39-1306 to 39-1307

39-1306-Small
39-1307-Large



Meyhoefer Chalazion Curette
39-1308 to 39-1312

39-1308- #0 1.5mm
39-1309- #1 1.7mm
39-1310- #2 2.2mm
39-1311- #3 2.5mm
39-1312- #4 3.0mm

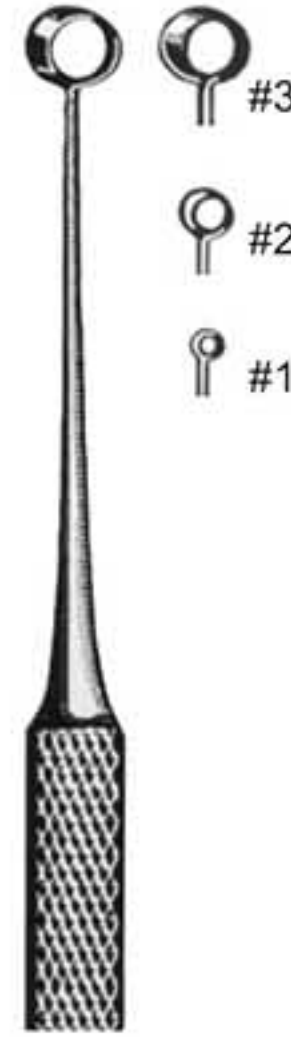

Heath Curette one Sharp & one Dull Edge
39-1313 to 39-1316

39-1313- #0 1/2 mm
39-1314- #1 1mm
39-1315- #2 2mm
39-1316- #3 3mm



Wilder Lacrimal Dilator
1317 to 1319

39-1317-Short Taper
39-1318-Medium Taper
39-1319-Long Taper



Muldoon Lacrimal Dilator 39-39-1320
Castroviejo Lacrimal Dilator 39-1321

39-1320-4.00"
39-1321-5.50"
D/Ended Tapers
22 mm x 18mm

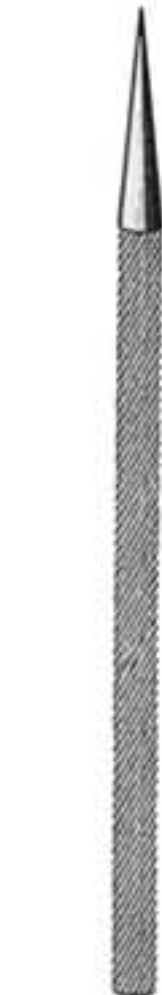

Infant Lacrimal Dilators
39-1322

39-1322-2.75" Extra
Delicate 0.5 mm at Tip

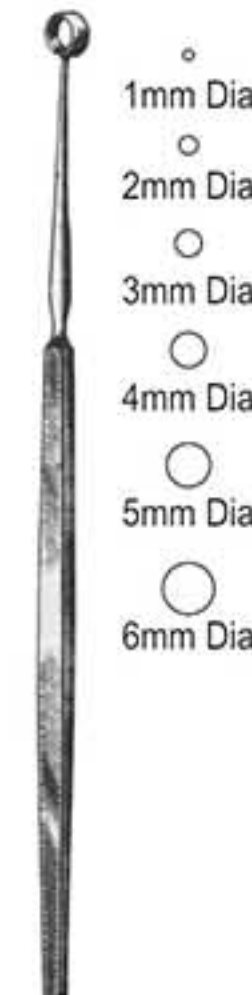

Fox Dermal Curettes
39-1323A - 39-1323F

39-1323A-5 1/2" Round 1mm Dia
39-1323B-5 1/2" Round 2mm Dia
39-1323C-5 1/2" Round 3mm Dia
39-1323D-5 1/2" Round 4mm Dia
39-1323E-5 1/2" Round 5mm Dia
39-1323F-5 1/2" Round 6mm Dia



Castroviejo Caliper
39-1324

39-1324- 3.25"
39-1324A-8.00"-straight
39-1324B-8.00"-curved

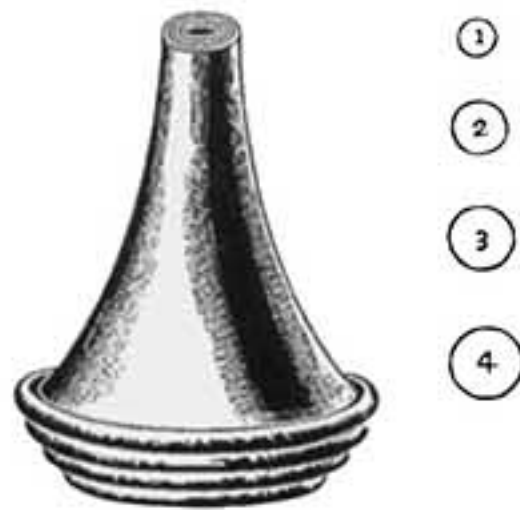

Boucheron Ear Speculum
40-1325

40-1325-Set of 4 Pcs.

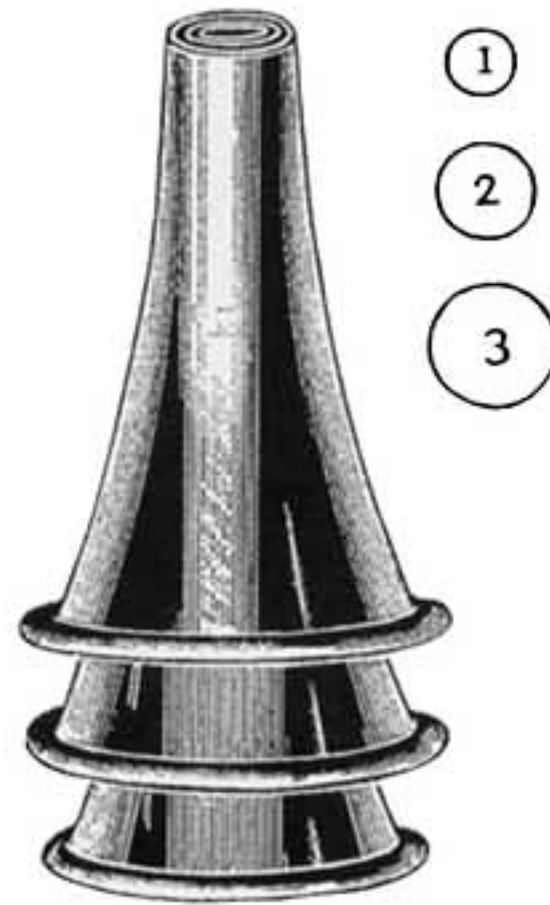

Toynebee Ear Speculum
40-1326 to 40-1329

40-1326-Set of 3 PCS.
40-1327-Small
40-1328-Medium
40-1329-Large

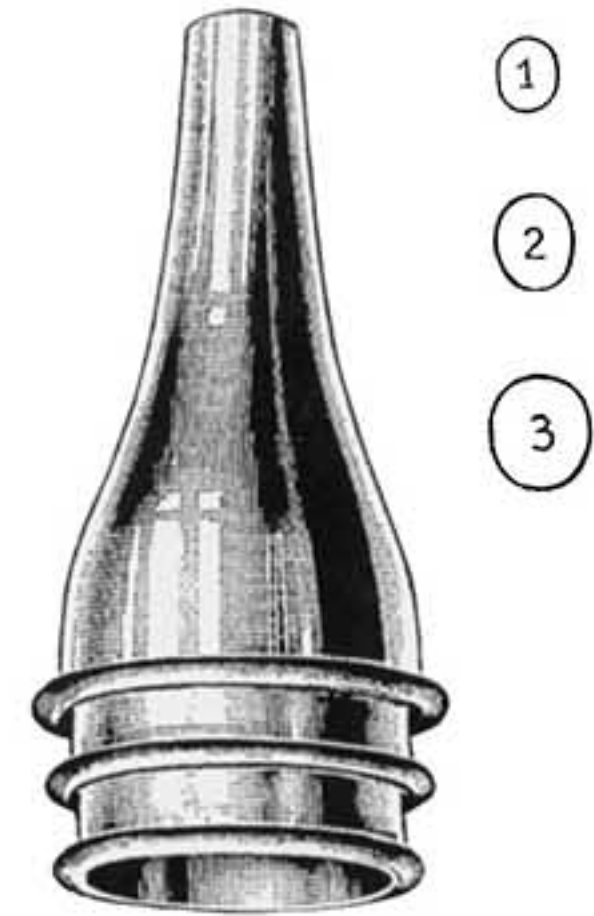

Gruber Ear Speculum
40-1330 to 40-1331

40-1330-Set of 3 PCS.
40-1331-Infant



Billeau Ear Loop
40-1332 to 40-1334

40-1332-Small
40-1333-Medium
40-1334-Large



Shapleigh Ear Curettes
40-1335 to 40-1336

40-1335-6.25" Small Size 1
40-1336-6.25" Large Size 2



Buck Ear Curette
40-1337 to 40-1348

40-1337-#000 Sharp Straight
40-1338-# 00 Sharp Straight
40-1339-# 0 Sharp Straight
40-1340-# 1 Sharp Straight
40-1341-# 2 Sharp Straight
40-1342-# 3 Sharp Straight
40-1343-#000 Sharp Angled
40-1344-# 00 Sharp Angled
40-1345-# 0 Sharp Angled
40-1346-# 1 Sharp Angled
40-1347-# 2 Sharp Angled
40-1348-# 3 Sharp Angled

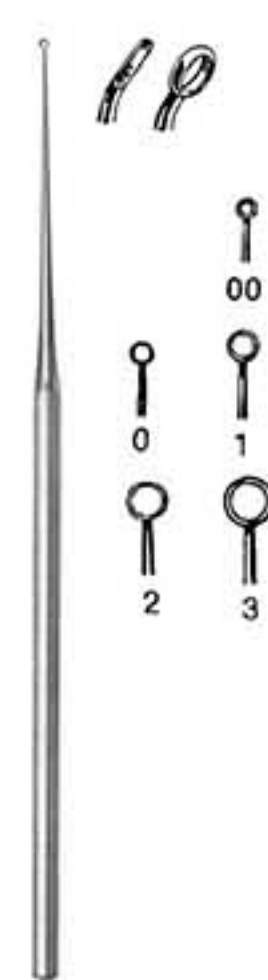

Buck Ear Curette
40-1349 to 40-1360

40-1349-#000 Blunt Straight
40-1350-# 00 Blunt Straight
40-1351-# 0 Blunt Straight
40-1352-# 1 Blunt Straight
40-1353-# 2 Blunt Straight
40-1354-# 3 Blunt Straight
40-1355-#000 Blunt Angle
40-1356-# 00 Blunt Angle
40-1357-# 0 Blunt Angle
40-1358-# 1 Blunt Angle
40-1359-# 2 Blunt Angle
40-1360-# 3 Blunt Angle



20 mm



22 mm

Regular Mirror Handle

41-1361MA to 41-1361MB

41-1361MA 20mm - #4
41-1361MB 22mm - #5



A



B



C



D



E

Handle only 41-1361HA
Simple thread 41-1361HB
Hollow chromium plated 41-1361HC
Solid stainless 41-1361HD
Hollow stainless 41-1361HE



10 mm



12 mm



14 mm



16 mm



18 mm



20 mm



22 mm



24 mm

Laryngel Mirror Regular Boilable

41-1362 to 41-1369

41-1362-#00 10mm
41-1363-# 0 12mm

41-1364-# 1 14mm 41-1367-# 4 20mm
41-1365-# 2 16mm 41-1368-# 5 22mm
41-1366-# 3 18mm 41-1369-# 6 24mm

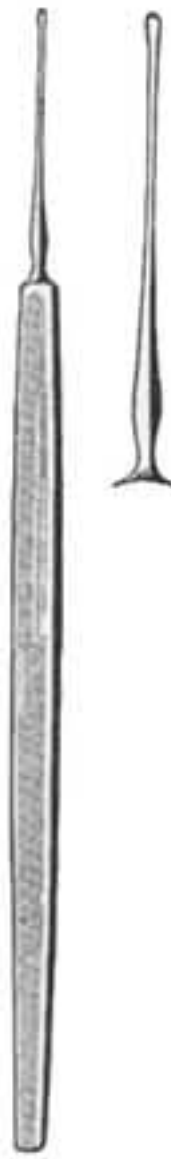

Francis Foreign Body Spud
42-1370

Davis Foreign Body Spud
42-1371

Ziegler Knife-Needle
42-1372 to 42-1375

Von Graefe Cystotome
42-1376

Von Graefe Cystotome
42-1377

Von Graefe Cystotome
42-1378

42-1370
Flag Shape Blade

42-1371
Chisel Shape

42-372 - Angular Blade 4.50"
Size 0 - 03 mm Blade
42-373 - Angular Blade 4.50"
Size 1 - 15 mm Blade
42-1374-Angular Blade 4.50"
Size 2 - 26 mm Blade
42-1375-Angular Blade 4.50"
Size 3 - 37 mm Blade

42-1376-Right Angle
Flexible

42-1377-Left Angle
Flexible

42-1378-Straight
Flexible



Wilder Grafe Cystotome
42-1379

Barkan Goniotomy Knife
42-1380

Gill Corneal Knife
42-1381

Tooke Corneal Knife
42-1382

42-1379-Flexible

42-1380-4.50"

42-1381 -4.75"
Blade is Slightly Curved on Flat

42-1382-4.50"

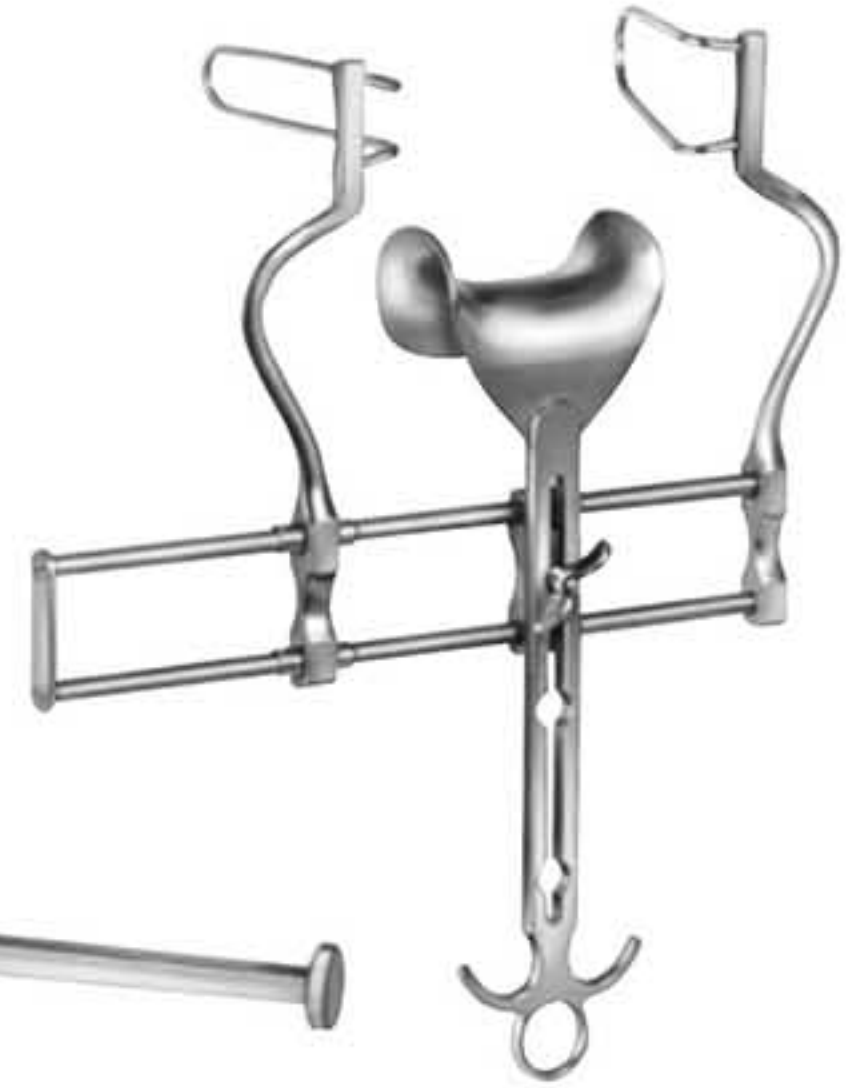

Farabeuf Retractors
43-819 to 43-820

Parker Retractors
43-822 to 43-823

Nelson Retractor (Baby Balfour)
43-843

Balfour Retractor
43-844 to 43-845

43-819-5.00" Set of 2
43-820-6.00" Set of 2

43-822-5.00" Set of 2
43-823-7 1/2" Set of 2

43-843 -1 x 2.50
Blade 5.50" Spread

43-844 - 2" Deep 7.00" Spread
43-844A - 2" Deep 6.00" Spread
43-845 - 2" Deep 10.00" Spread

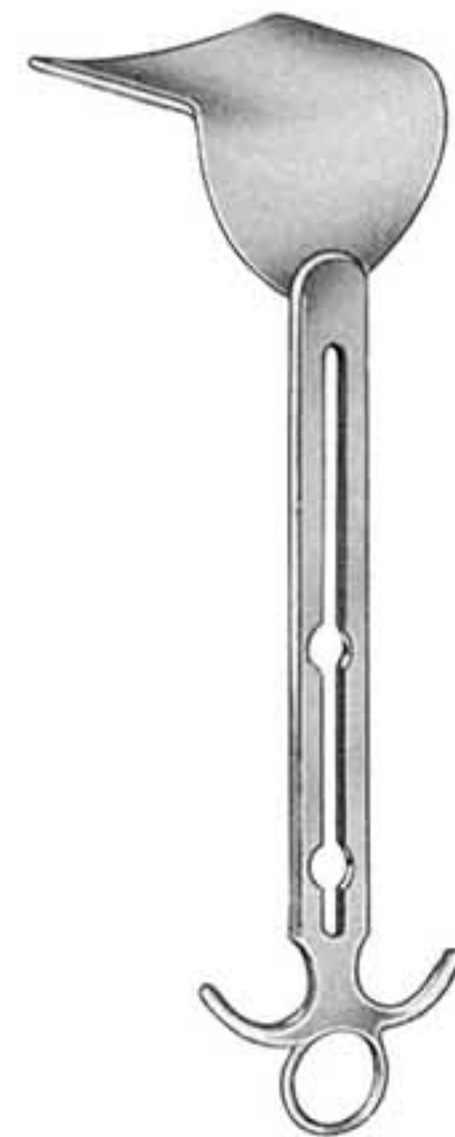

Balfour Retractor
43-846 to 43-847

Balfour Center Blade
43-847-A 43-847-B

43-846-4.00" Deep 7.00" Spread
43-847-4.00" Deep 10.00" Spread



Weitlaner Self-Retaining Retractor
44-1501 to 44-1508

44-1501-4.5" 2x3 Prong B/B
 44-1502-4.5" 3x4 Prong B/B
 44-1503-5.5" 3x4 Prong B/B
 44-1504-6.5" 3x4 Prong B/B
 44-1505-4.5" 2x3 Prong S/S
 44-1506-4.5" 3x4 Prong S/S
 44-1507-5.5" 3x4 Prong S/S
 44-1508-6.5" 3x4 Prong S/S



Weitlaner-Beckman Retractor
44-1509 to 44-1510

44-1509 -5.½" 3x4 Prong S/S
 44-1510 -5.½" 3x4 Prong B/B
 44-1509A-6.00" 3x4 Prong S/S
 44-1510A-6.00" 3x4 Prong B/B
 44-1509B-9.00" 3x4 Prong S/S
 44-1510B-9.00" 3x4 Prong B/B



Gelpi Retractor
44-1511 to 44-1515

44-1511- 3.50"
 44-1512- 5.50"
 44-1513- 6.50"
 44-1514- 7.00"
 44-1515-10.00"



Rigby Retractor
44-1516

44-1516-7.00"



Jansen Self-Retaining Retractor
44-1517

44-1517-4.00"
 Blunt 3 x 3 Blades



Self-Retaining Retractor Delicate
44-1518

44-1518-1.5"
 Sharp 3 x 3 Prong



ALM Retractor
44-1519 to 44-1520

44-1519
 2.75" Blunt 4x4 Prong
 44-1520
 4.00" Blunt 4x4 Prong



Automatic Skin Retractor
44-1521 to 44-1522

44-1521
 4.00" Sharp 4x4 Prong
 44-1522
 4.00" Blunt 4x4 Prong

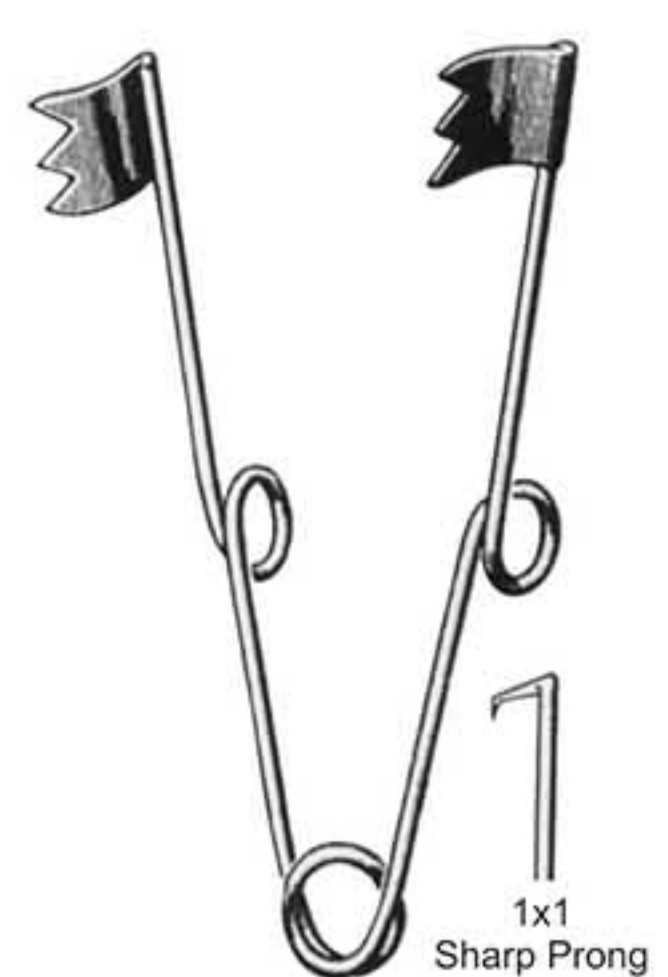

Wire Retaining Retractor
44-1523 to 44-1524

44-1523-3.25" 3x3 Prong
 44-1524-3.25" Sharp 1x1 Prong

1x1
 Sharp Prong



0 Sullivan-0-Connor Abdominal Retractor
W/3 Interchangeable Blades 2 Large, 1 Small
45-1525-7.00"



Volkman Retractor (USA)
45-1526 to 45-1529 45-1530 to 45-1533



Volkman Retractor (Ring Handle)
45-1534 to 45-1537 45-1538 to 45-1541

Vaginal Abdominal	45-1526 - Sharp 2 Prong	45-1530 - Blunt 2 Prong	45-1534 - Sharp 2 Prong	45-1538 - Blunt 2 Prong
45-1525 -7.00" 080 x 45 mm	45-1527 - Sharp 3 Prong	45-1531 - Blunt 3 Prong	45-1535 - Sharp 3 Prong	45-1539 - Blunt 3 Prong
45-1525A-7.00" 110 x 70 mm	45-1528 - Sharp 4 Prong	45-1532 - Blunt 4 Prong	45-1536 - Sharp 4 Prong	45-1540 - Blunt 4 Prong
	45-1529 - Sharp 6 Prong	45-1533 - Blunt 6 Prong	45-1537 - Sharp 6 Prong	45-1541 - Blunt 6 Prong



Hernia Retractor
45-1542
45-1542-6.00"
Double Ended



Senn Muller Retractor
45-1543 to 45-1544
45-1543-6.25" Sharp
45-1544-6.25" Blunt



Mathieu Retractor
45-1545
45-1545-6.25"
Blunt Double Ended



Meyerding Skin Hook & Retractor
45-1546
6.25"



Little Retractor
45-1547
1.20 x 7.25"



McBurney Retractor
45-1548
7.50"



Green Retractor
45-1549
8.50"

A TRADITION OF QUALITY A PROMISE OF VALUE.



Cushing Vein Retractor	Desmarres Lid Retractor	Paul Retractor	Lahey Retractor	Langenbeck Retractor	Young Anterior Retractor	Young Lateral Retractor
46-1550	46-1551 to 46-1554	46-1555	46-1556	46-1557 to 46-1559	46-1560	46-1561
9.00"	46-1551-# 1 5.5" 46-1552-# 2 5.5" 46-1553-# 3 5.5" 46-1554-# 4 5.5"	46-1555 4.75" 3 Prong	46-1556 7.00"	46-1557-9.00" 0.25 x 1-1/8 46-1558-9.00" 0.50 x 1-2.5 46-1559-9.00" 0.75 x 1-2.5	46-1560-8.00"	46-1561-8.25"



Young Bifurcated Retractor	Deaver Retractor Without Handle		Deaver Retractor Grip Handle		Meyerding Retractor
46-1562	46-1563 to 46-1572		46-1573 to 46-1579		46-1580
46-1562-8.50"	46-1563-# 000	0.75 x 7	46-1568-# 2.50	1 x 14	46-1580-9.25" Medium
	46-1564-# 00	7/8 x 8.50	46-1569-# 3	1.50 x 12	
	46-1565-# 0	1 x 9	46-1570-# 4	2 x 12	
	46-1566-# 1	1 x 12	46-1571-# 5	3 x 12	
	46-1567-# 2	1 x 13	46-1572-# 6	4 x 12	
			46-1573-# 0	1 x 10	
			46-1574-# 1	1 x 12	
			46-1575-# 2	2 x 12	
			46-1576-# 2.50	1 x 14.50	
			46-1577-# 3	1.20 x 12	
			46-1578-# 4	2 x 12	
			46-1579-# 5	3 x 12	

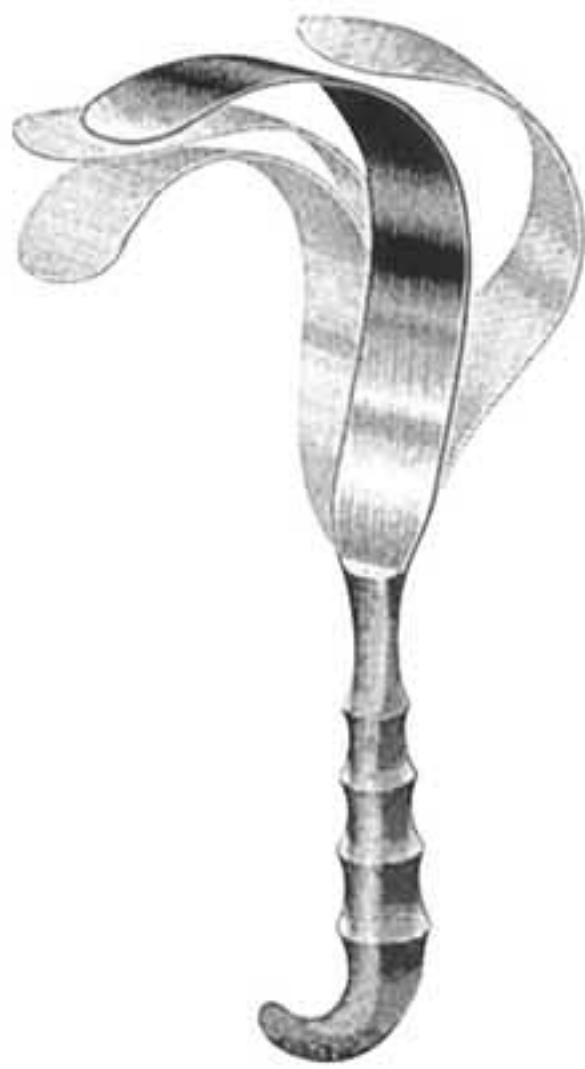

Zalkind Lung Retractor
47-1581 to 47-1582

47-1581 - Malleable 2 x 12
47-1582 - Malleable 3 x 12



Zalkind (Ribbon) Retractor
47-1583 to 47-1593

47-1583 - Malleable 0.25x7
47-1584 - Malleable 0.50x7
47-1585 - Malleable 0.75x7
47-1586 - Malleable 1 x 7
47-1587 - Malleable 0.75x13
47-1588 - Malleable 1x13
47-1589 - Malleable 1.25x13
47-1590 - Malleable 1.50x13
47-1591 - Malleable 1.75x13
47-1592 - Malleable 2x13
47-1593 - Malleable 2.50x13

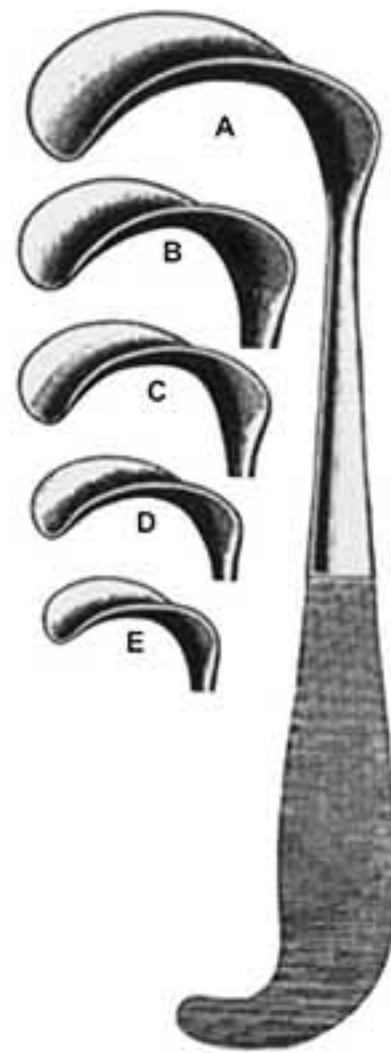

Brewster Retractor
47-1594 to 47-1598

47-1594-Style A 2.50x1.75
47-1595-Style B 2.25x1.75
47-1596-Style C 2.00x1.75
47-1597-Style D 1.75x1.00
47-1598-Style E 0.75x1.50



Richardson Retractor
47-1599 to 47-1602

47-1599-9.50" 0.75x1.00
47-1600-9.50" 1.00x1.25
47-1601-9.50" 1.50x1.50
47-1602-9.50" 0.75x2.00



Heaney Retractor
47-1603 to 47-1605

47-1603-10.50" 1.75x1.00
Small Blade
47-1604-10.50" 2.25x1.25
Medium Blade
47-1605-10.50" 3.25x1.25
Large Blade



U.S. Army Pattern Retractor
47-1606

47-1606-8.50" Set 2 Pcs.



Kelly Retractor
47-1607 to 47-1610

47-1607-9.00" 1.50x2.00
47-1608-9.50" 2.00x2.50
47-1609-10.00" 2.50x3.00
47-1610-10.50" 2.75x3.25



Richardson-Eastman Retractor
47-1611 to 47-1612

47-1611-A set of 2
47-1611- 9.50"
47-1612-10.25"



Aufrecht Retractor
47-1613

47-1613-7.25" x 1.25"

A TRADITION OF QUALITY A PROMISE OF VALUE.



Tracheal Retractor		Jackson Tracheal Retractor	Plastic Surgery Retractor	Hupp Tracheal Retractor	Lahey Retractor
48-1614 to 48-1616	48-1617 to 48-1619	48-1620	48-1621 to 48-1624	48-1625	48-1626 to 48-1628
48-1614-6.50" Sharp 1 Prong	48-1617-6.50" Blunt 1 Prong	48-1620-7.00" Blunt D/Prong	48-1621-6.00" Sharp 2 Prong	48-1625-6.00" Sharp & Blunt Hook D/Ended	48-1626-4.75" Sharp 1 Prong
48-1615-6.50" Sharp 2 Prong	48-1618-6.50" Blunt 2 Prong		48-1622-6.00" Sharp 3 Prong		48-1627-4.75" Sharp 2 Prong
48-1616-6.50" Sharp 3 Prong	48-1619-6.50" Blunt 3 Prong		48-1623-6.00" Blunt 2 Prong		48-1628-4.75" Sharp 3 Prong
			48-1624-6.00" Blunt 3 Prong		



News Hook	Joseph Skin Hook	Guthie Double Hook	Fomon Retractor	Blair (Rollet) Retractor
48-1629	48-1630 to 48-1634	48-1635	48-1636 to 48-1637	48-1638 to 48-1639
48-1629-6.00"	48-1630 - 6.25" Single Ended Sharp 1 Prong	48-1635-5.00" Sharp	48-1636-6.25" Ball End Single	48-1638-5.50" Sharp 4 Prong
	48-1631 - 6.25" Double Ended Sharp 2 Prong 2mm		48-1637-6.25" Ball End Double	48-1639-5.50" Blunt 4 Prong
	48-1632 - 6.25" Double Ended Sharp 2 Prong 5mm			
	48-1633 - 6.25" Double Ended Sharp 2 Prong 7mm			
	48-1634 - 6.25" Double Ended Sharp 2 Prong 10mm			

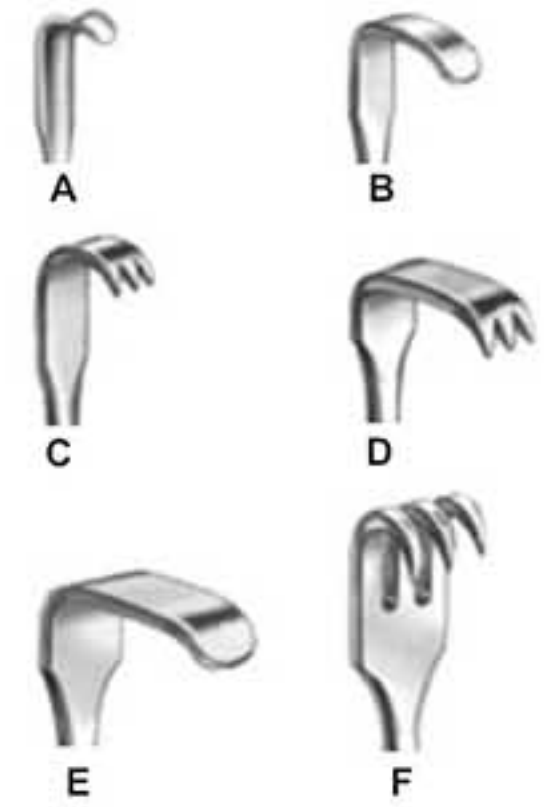

Gillies Skin Hook
49-1640 to 49-1641

Tyrell Iris Hook
49-1642 to 49-1643

Frazier Tissue Hook
49-1644 to 49-1645

Emmett Hook 9"
49-1646 to 49-1650

Meyerdig Retractor
49-1651 to 49-1656

49-1640-7.00" 3 mm
49-1641-7.00" 4 mm

49-1642-Sharp
49-1643-Blunt

49-1644-5.00" Sharp
49-1645-5.00" Blunt

49-1646-9.00" Style 1
49-1647-9.00" Style 2
49-1648-9.00" Style 3
49-1649-9.00" Style 4
49-1650-9.00" Style 5

49-1651-7.00" A
49-1652-7.00" B
49-1653-7.00" C
49-1654-7.00" D
49-1655-7.00" E
49-1656-7.00" F 3 Prong Sharp

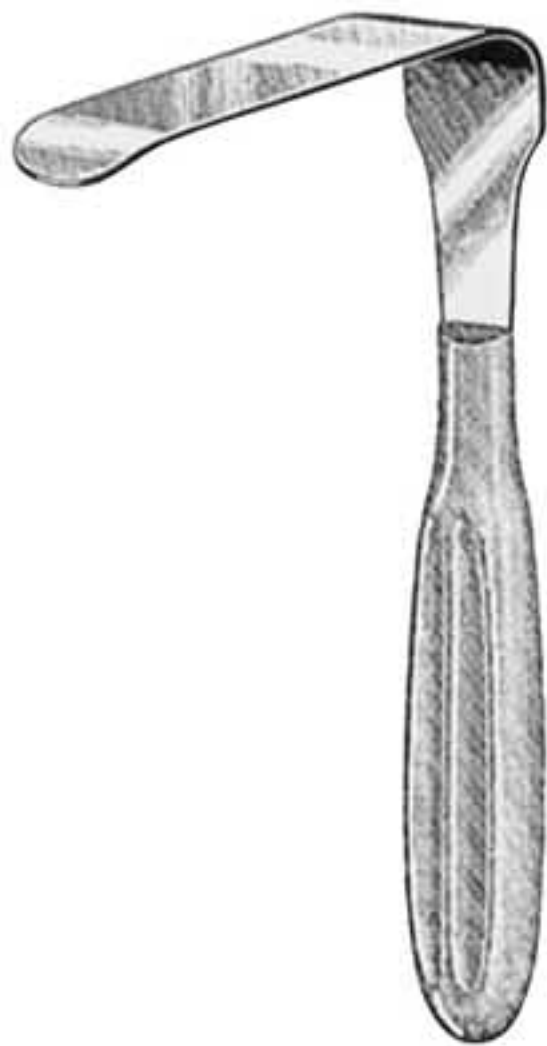

Brantley-Turner Retractor
49-1657

Pryor-Pean Retractor
49-1658

Delee Retractor
49-1659 to 49-1661

Mayo Abdominal Retractor
49-1662

Fritch Retractor
49-1663

49-1657-7.00" 4 x 1.25

49-1658-10.75" 4.50 x 1

49-1659-2.75x2 Right
49-1660-2.75x2 Left
49-1661-2.75x2 Universal

49-1662-2.75 x 10

49-1663-2.75 x 2



Doyen Abdominal Retractor
50-1664

50-1664-9.75" 3.50 x 2 Straight



Doyen Retractor
50-1665 to 50-1667

50-1665-8.50" 1.75x2.50
50-1666-8.50" 2.25x3
50-1667-8.50" 2.25x3.50



Sims-Kelly Retractor
50-1668 to 50-1670

50-1668-2.25x1
50-1669-2.75x1.75
50-1670- 3x1.50



Sims Retractor
50-1671 to 50-1676

50-1671-# 1 Double Ended Small
50-1672-# 2 Double Ended Medium
50-1673-# 3 Double Ended Large



Sims Retractor
50-1677 to 50-1679

50-1677- Single Ended
50-1678- Single Ended
50-1679- Single Ended

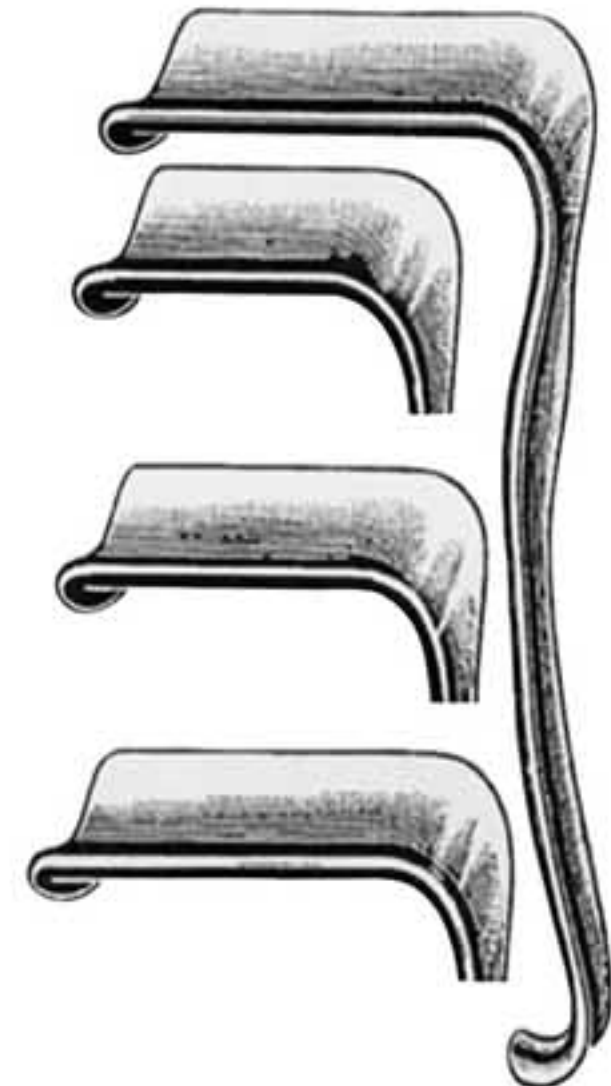

Eastman Retractor
50-1680 to 50-1682

50-1680-Small
50-1681-Medium
50-1682-Large



Graves Vaginal Speculum

51-512 to 51-517

- 51-512-Small
- 51-514-Medium
- 51-516-Large
- 51-517-XLarge

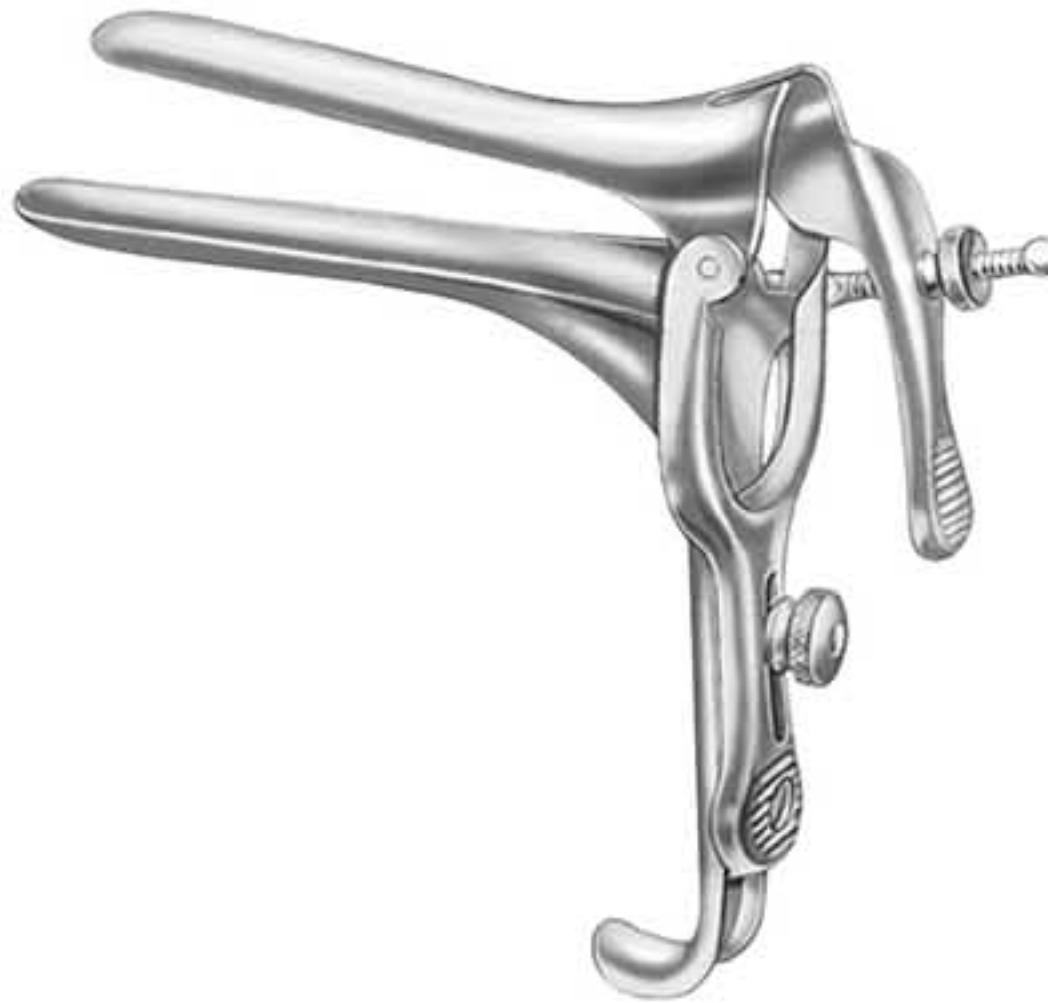

Pederson Vaginal Speculum

51-518 to 51-523

- 51-518-Small
- 51-520-Medium
- 51-522-Large
- 51-523-Extra Large



Sims Uterine Sound Malleable

51-722 to 51-726

- 51-722-Straight
- 51-724-H. Curved
- 51-726-F. Curved



**Hegar Uterine Dilator Sets of
8 Pcs. Single Ended**

51-831

51-831 - (3/4mm, 5/6mm, 7/8mm, 9/10mm, 11/12mm,
13/14mm, 15/16mm, 17/18mm)



**Hegar Uterine Dilator Sets of
8 Pcs. Double Ended**

51-832

51-832 - (3/4mm, 5/6mm, 7/8mm, 9/10mm, 11/12mm,
13/14mm, 15/16mm, 17/18mm)



**Graves Vaginal
Speculum Leep / Lietz**

51A-512 to 51A-517

- 51A-512 SBC-Small
- 51A-514 MBC-Medium
- 51A-516 LBC-Large
- 51A-517 BCX-Large



**Pederson Vaginal
Speculum Leep / Lietz**

51A-518SBC to 51A-523BCX-L

- 51A-518 SBC-Small
- 51A-520 MBC-Medium
- 51A-522 LBC-Large
- 51A-523 BCX-Large



**Graves Vaginal
Speculum/Extrawide**

51A-514VM
extreme wide for
view normal

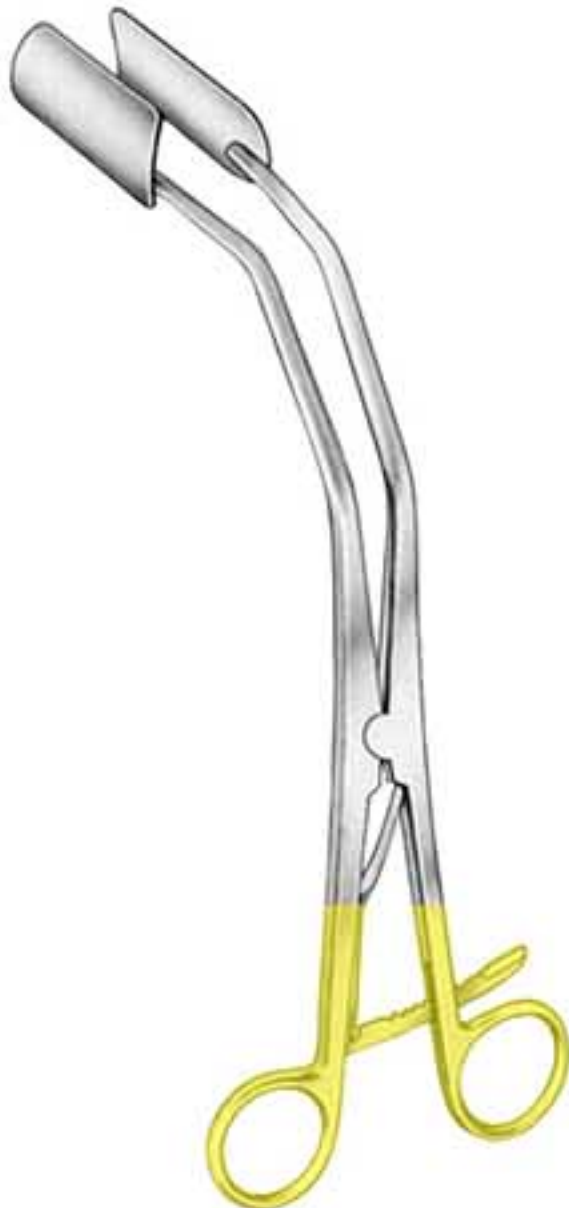

**Lateral Vaginal
Retractor**

51A-963

Size 8.25"



**Lateral Vaginal Retractor
Blue Coated Leep / Lietz**

51A-963 BC

Size 8.25"



Thomas Uterine Curettes
52-862 Blunt

- 52-862/1B - Blunt #1
- 52-862/2B - Blunt #2
- 52-862/3B - Blunt #3
- 52-862/4B - Blunt #4
- 52-862/5B - Blunt #5
- 52-862/6B - Blunt #6

Sims Uterine Curettes
52-862 Sharp

- 52-862/1S - Sharp #1
- 52-862/2S - Sharp #2
- 52-862/3S - Sharp #3
- 52-862/4S - Sharp #4
- 52-862/5S - Sharp #5
- 52-862/6S - Sharp #6

Heany Uterine Biopsy Curettes
52-862 HN - 52-862 HNM S/S

9" (22.9 cm)
serrated loop



Poole Suction Tube	Adson Suction Tube	Frazier Suction Tube	Baron Suction Tube	Yankauer Suction Tube	Buie Suction Tube
53-1401 to 53-1403	53-1404	53-1405 to 53-1409	53-1410 to 53-1412	53-1413	53-1414 to 53-1415
53-1401-16 F Curved 53-1402-23 F Curved 53-1403-30 F Straight	53-1404-6.00" 12 F	53-1405- 6F 53-1406- 7F 53-1407- 8F 53-1408-10F 53-1409-12F	53-1410-3F 53-1411-5F 53-1412-7F	53-1413A-8" Pediatric 53-1413B-11"	53-1414-15 F With Valve 53-1415-15 F Without Valve

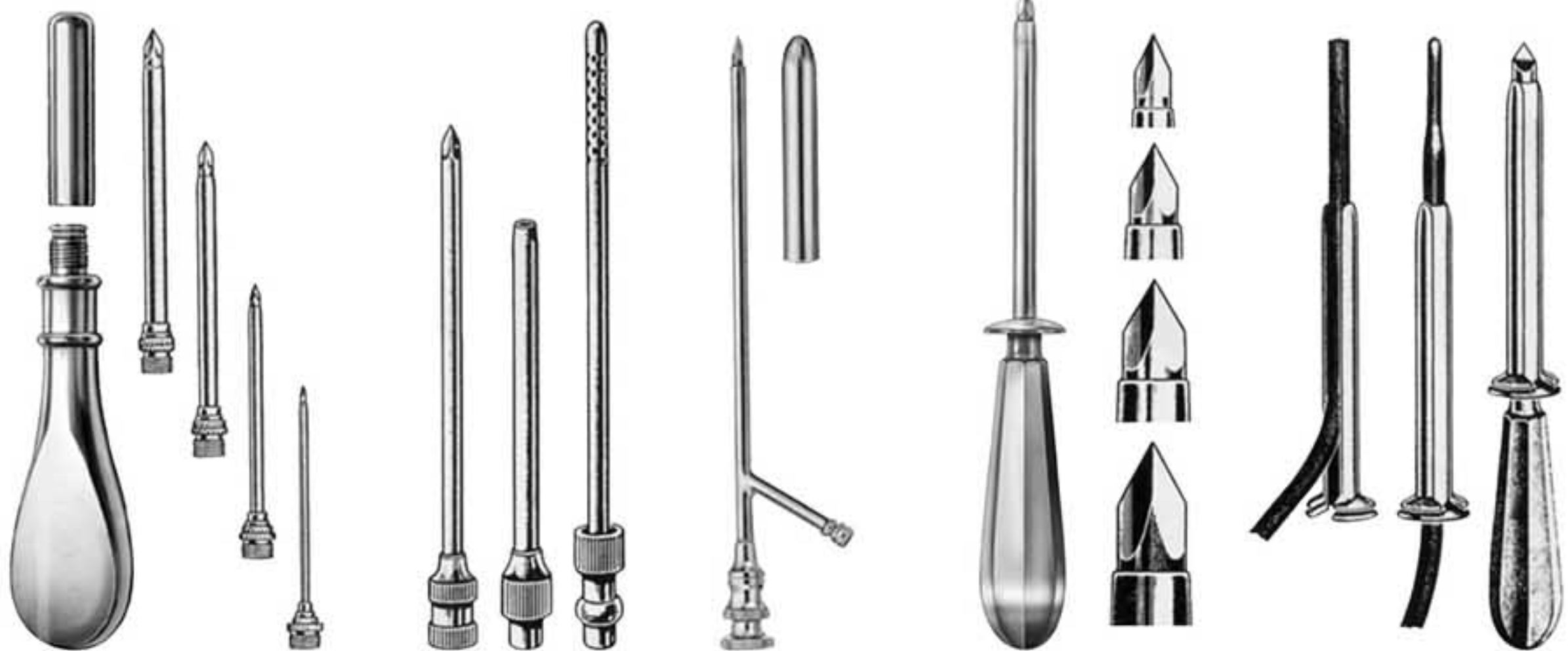

Trocar Set of Four	Duke Improved Trocar	Ochsner Trocar	Nelson Trocar	Hurwitz Trocar
53-1416	53-1417	53-1418 to 53-1423	53-1424 to 53-1427	53-1428 to 53-1430
53-1416-5.50" 6 F, 9 F, 13 F, 17 F	53-1417-4.50" 17 F	53-1418-10 Fr. 6 Fr. Cath 53-1419-14 Fr. 10 Fr. Cath 53-1420-17 Fr. 12 Fr. Cath 53-1421 -20Fr. 16 Fr. Cath 53-1422-24 Fr. 20 Fr. Cath 53-1423-28 Fr. 22 Fr. Cath	53-1424-#1 8.25" 25 Fr. 53-1425-#2 8.25" 30 Fr. 53-1426-#3 8.25" 33 Fr. 53-1427-#4 8.25" 35 Fr.	53-1428-22 Fr. 53-1429-26 Fr. 53-1430-36 Fr.

Collin Vaginal Speculum
 55-1443

 55-1443A-Vergin
 55-1443B-Small
 55-1443C-Medium
 55-1443D-Large

CUSCO Vaginal Speculum
 55-1444 to 55-1446

 55-1444-Small
 55-1445-Medium
 55-1446-Large

Auvard Weighted Vaginal Speculum
 55-1447 to 55-1449

 55-1447-Light 2.00 Lbs
 55-1448-Medium 2.50 Lbs
 55-1449-Large 3.00 Lbs

Garrigue Weighted Vaginal Speculum
 55-1450 to 55-1452

 55-1450-Light 2.00 Lbs
 55-1451-Medium 2.50 Lbs
 55-1452-Large 3.00 Lbs

Kogan Endocervical Speculum
 55-1453

 55-1453
 W/Gauge & Screw
 Narrow Wire Blade

Female Catheters
 55-1454 to 55-1459

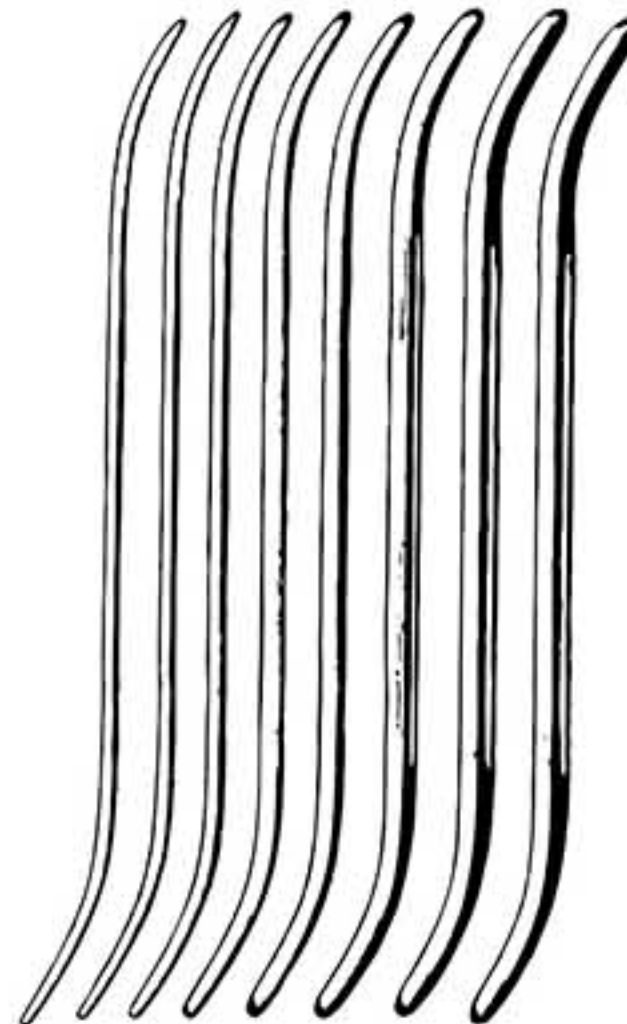
 55-1454-10 Fr. 55-1457-16 Fr.
 55-1455-12 Fr. 55-1458-18 Fr.
 55-1456-14 Fr. 55-1459-20 Fr.

Pratt Uterine Dilator Set of 8 pcs.
 55-1460

 55-1460-(13-15 Fr. 17-19 Fr.
 21-23 Fr. 25-27 Fr. 29-31 Fr.
 33-35 Fr. 37-39 Fr. 39-41 Fr.)

Hank Uterine Dilator Sets of 6 Pcs.
 55-1461

 55-1461-(9-10,11-12,13-14,
 15-16,17-18,19-20)



Kelly Protoscope
56-1490 to 56-1492A

Kelly Protoscope
56-1493 to 56-1494

- 56-1490 -22 x 50
- 56-1491 -22 x 100
- 56-1492 -22 x 140
- 56-1492A-22 x 200

- 56-1493-21, L 50 mm
- 56-1494-27, L 50 mm



**Kevorkian-Young
Endoceleval Curette**
56-1463

Ives Fansler
56-1495

**IUD Extractor
Hook's**
56-1496

Mathieu Rectal Speculum
56-1497

56-1463-12.00"
56-1463A (with basket)

56-1495-22mm, L 80mm

56-1496-10.50"

56-1497-19.50 cm

A TRADITION OF QUALITY A PROMISE OF VALUE.

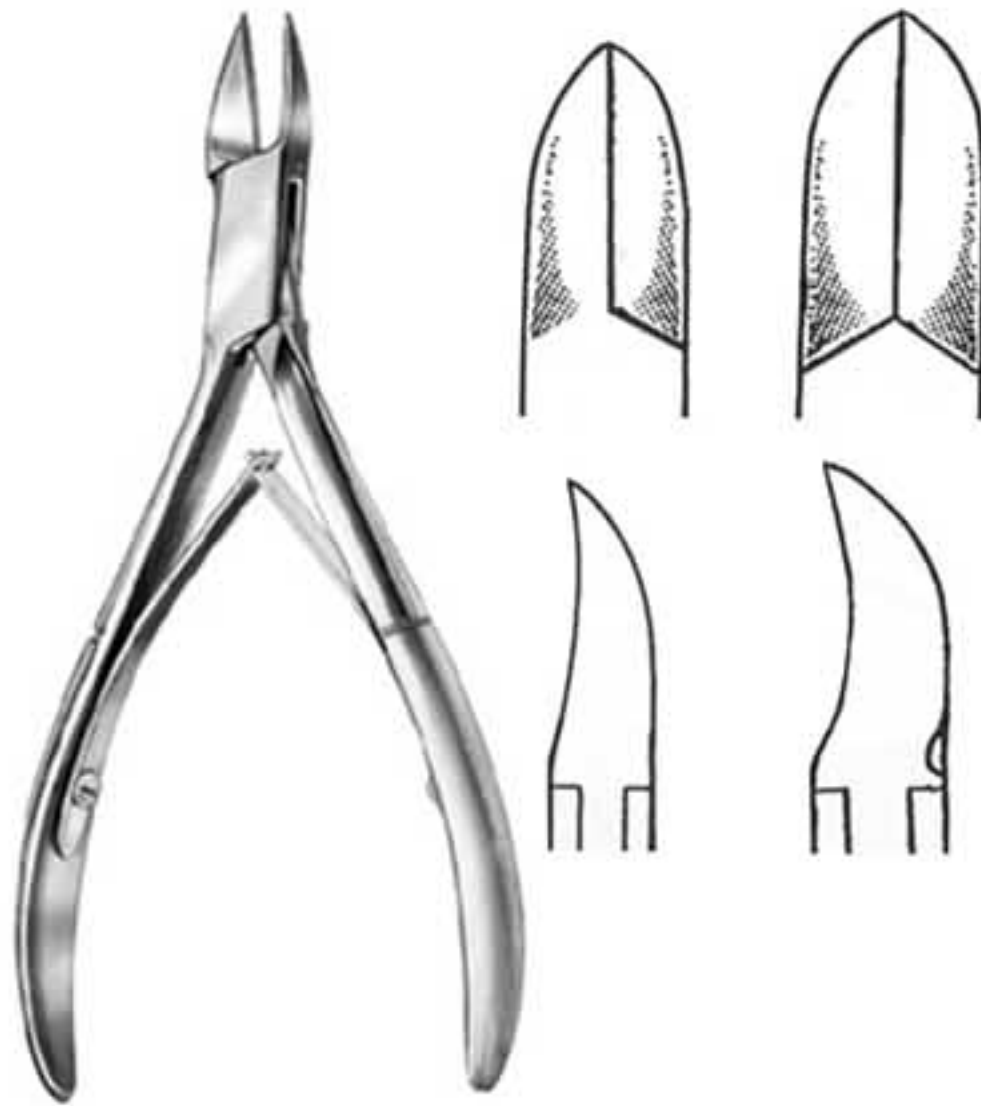
Toe Nail Nipper Double Spring
 57-1701 to 57-1703

 57-1701-4.00"
 57-1702-4.50"
 57-1703-4.75"

Toe Nail Nipper Single Spring
 57-1704 to 57-1706

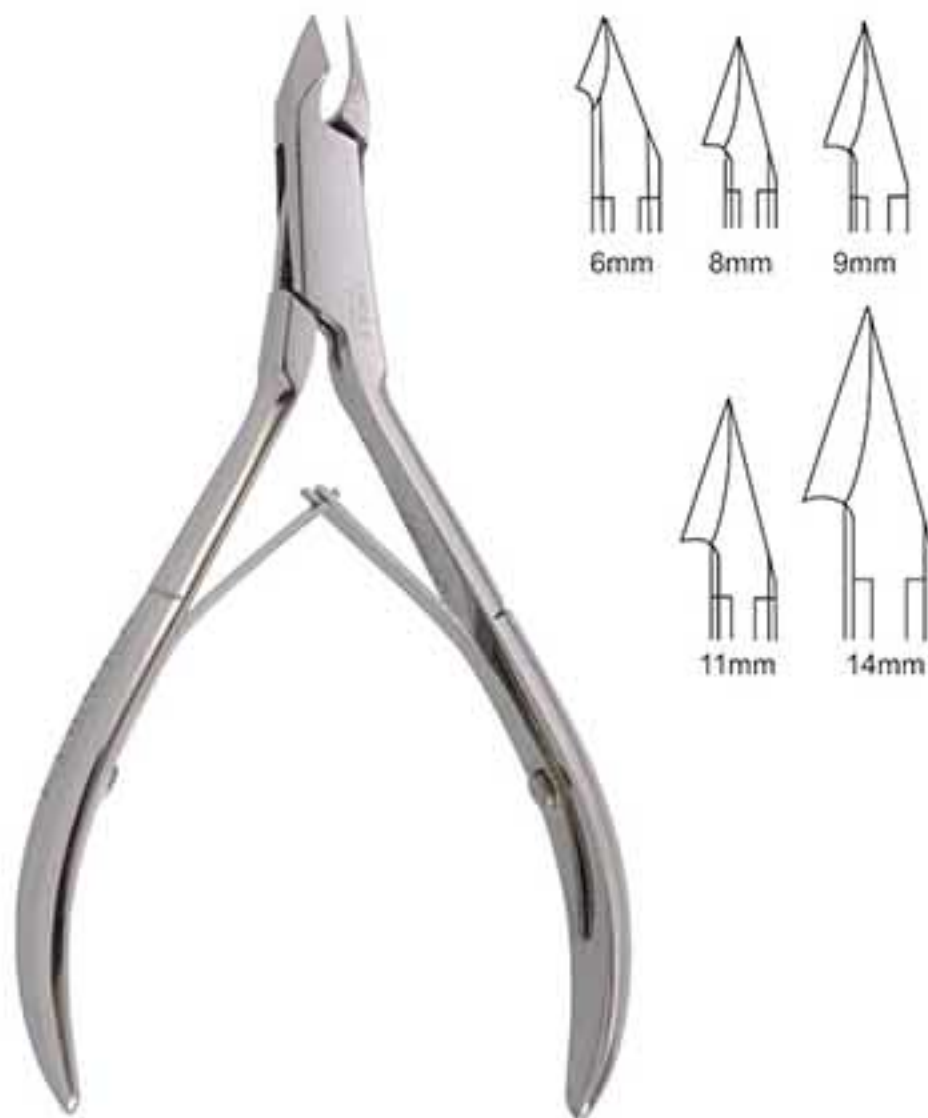
 57-1704-4.00"
 57-1705-4.50"
 57-1706-4.75"

Tissue Nipper
 57-1707 to 57-1711

 57-1707-4.00" 6mm
 57-1708-4.00" 8mm
 57-1709-4.00" 9mm
 57-1710-4.00" 11 mm
 57-1711-4.00" 14 mm

Tissue Forceps (Cuticle Nipper)
 57-1712

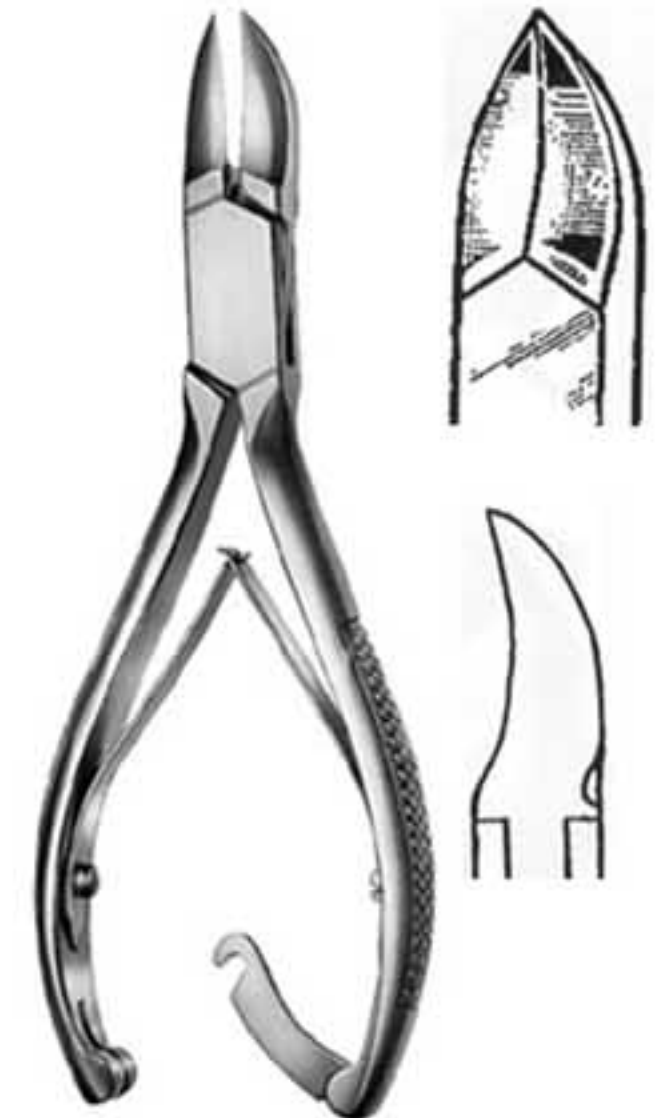
57-1712-4.00"

Toe Nail Cutter (Nipper) Concave Jaw
 57-1713 to 57-1714

 57-1713- 4.50" D/ Spring, W Look
 57-1714-5.50" D/Spring, W Look

A TRADITION OF QUALITY A PROMISE OF VALUE.



**Toe Nail Cutter
Concave Jaw**

58-1715 to 58-1716

58-1715 - 4.50" Barrel Spring, W Look
58-1716 - 5.50" Barrel Spring, W Look



Toe Nail Cutter Flats Jaw

58-1717

58-1717 - 5.50"
Double Spring, W Lock



Nail Cutter Moon Shape

58-1718

58-1718 - 5.50" 8 mm

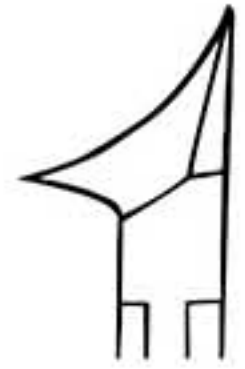

Ingrown Toe Nail Forceps

58-1719

58-1719 - 5.00"



Littauer Cutting Forceps

58-1720 to 1723

58-1720-4.00"
58-1721-4.50"
58-1722-5.00"
58-1723-6.00"

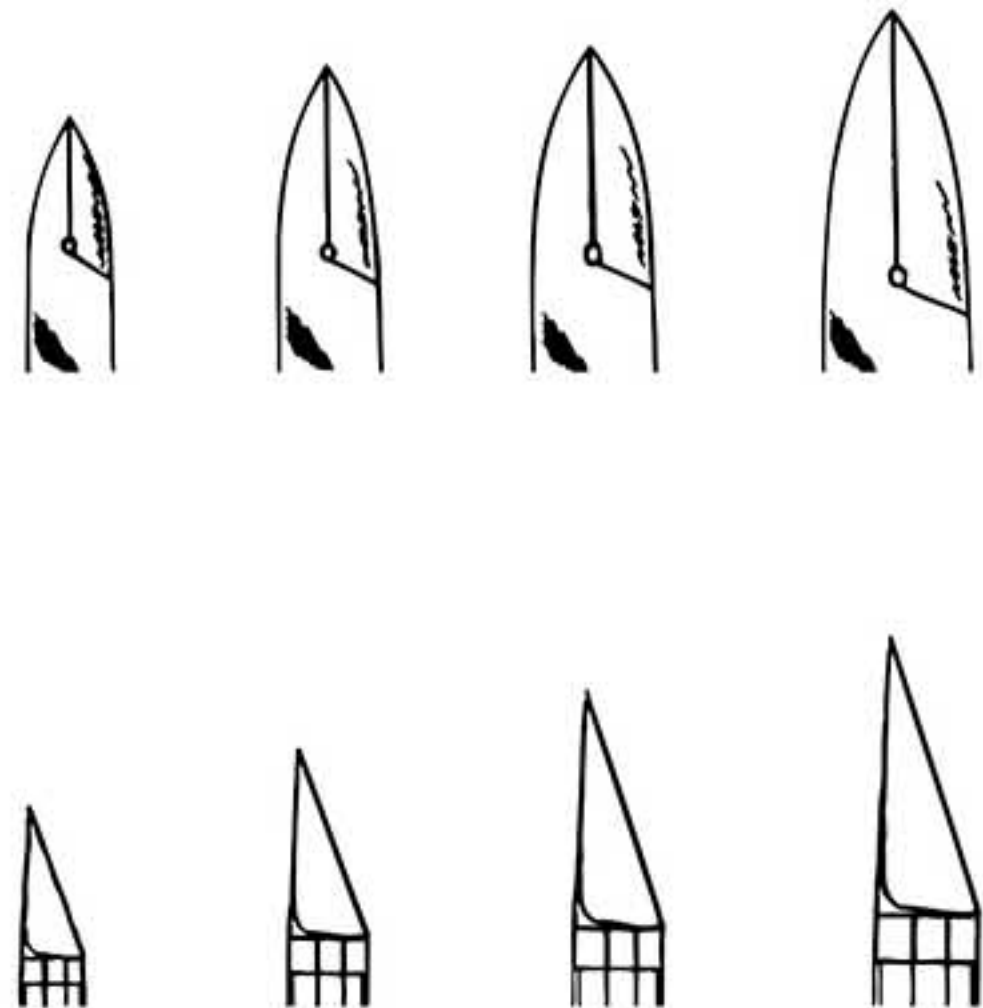

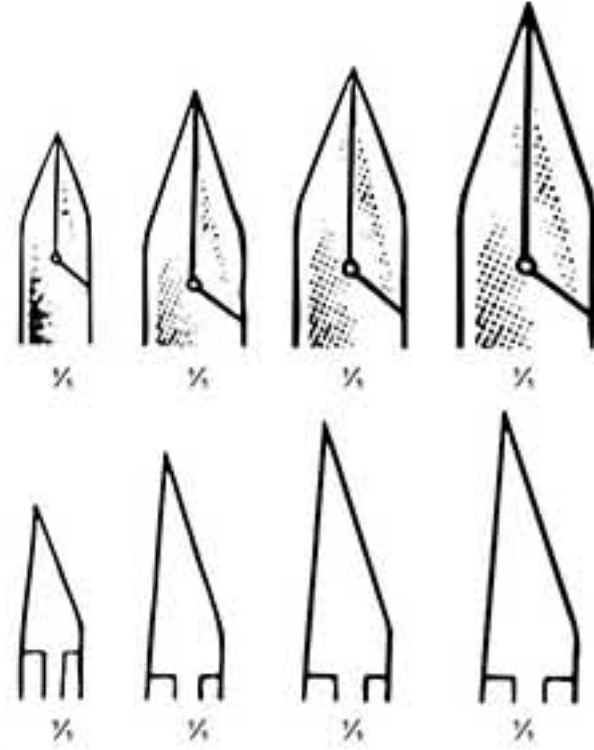
Nail Splitter (Cutter)

59-1724 to 59-1727

 59-1724 - 4.00"
 59-1725 - 4.50"
 59-1726 - 5.00"
 59-1727 - 6.00"

Liston Bone Forceps

59-1728 to 59-1730 59-1731 to 59-1733

 59-1728 - 5.50" Straight 59-1731 - 5.50" Curved
 59-1729 - 7.75" Straight 59-1732 - 7.75" Curved
 59-1730 - 8.75" Straight 59-1733 - 8.75" Curved

Pna Forceps (Cutting)

59-1734

59-1734 - 4.50"

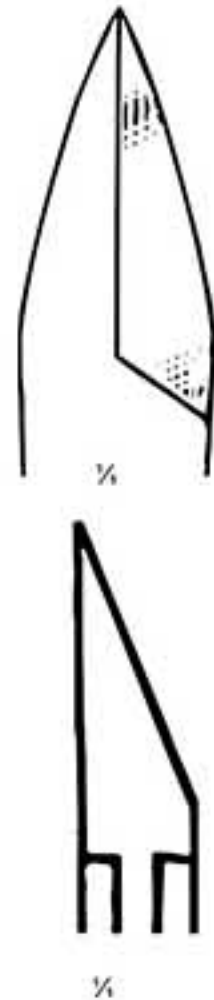
Liston Bone Cutting Forceps

59-1735

59-1735 - 5.50" Sharpe

Ruskin Liston Double Action

59-1736 to 59-1737

 59-1736 - 6.00" Straight
 59-1737 - 6.00" Curved

Ruskin Splitting Forceps

59-1740

59-1740 - 7.25" Straight-delicate



Ruskin-Liston Bone Cutting Forceps
60-1738 to 60-1739

60-1738 - 7.25" Straight
60-1739 - 7.25" Curved



Stille-Liston Bone Cutting Forceps
60-1741 to 60-1742

60-1741 - 10.50" Straight
60-1742 - 10.50" Curved



Ruskin-Liston Delicate
60-1743 to 60-1744

60-1743 - 6.00" Straight
60-1744 - 6.00" Curved



Rowlad Bone Cutting Forceps
60-1745

60-1745 - 7.00" Narrow Jaws



Stille-Horsley Bone Cutting Forceps
60-1746

60-1746 - 10.50" Bayonet, Multiple Action



Dean Bone Rongeur
60-1747

60-1747 - 5.50" Curved

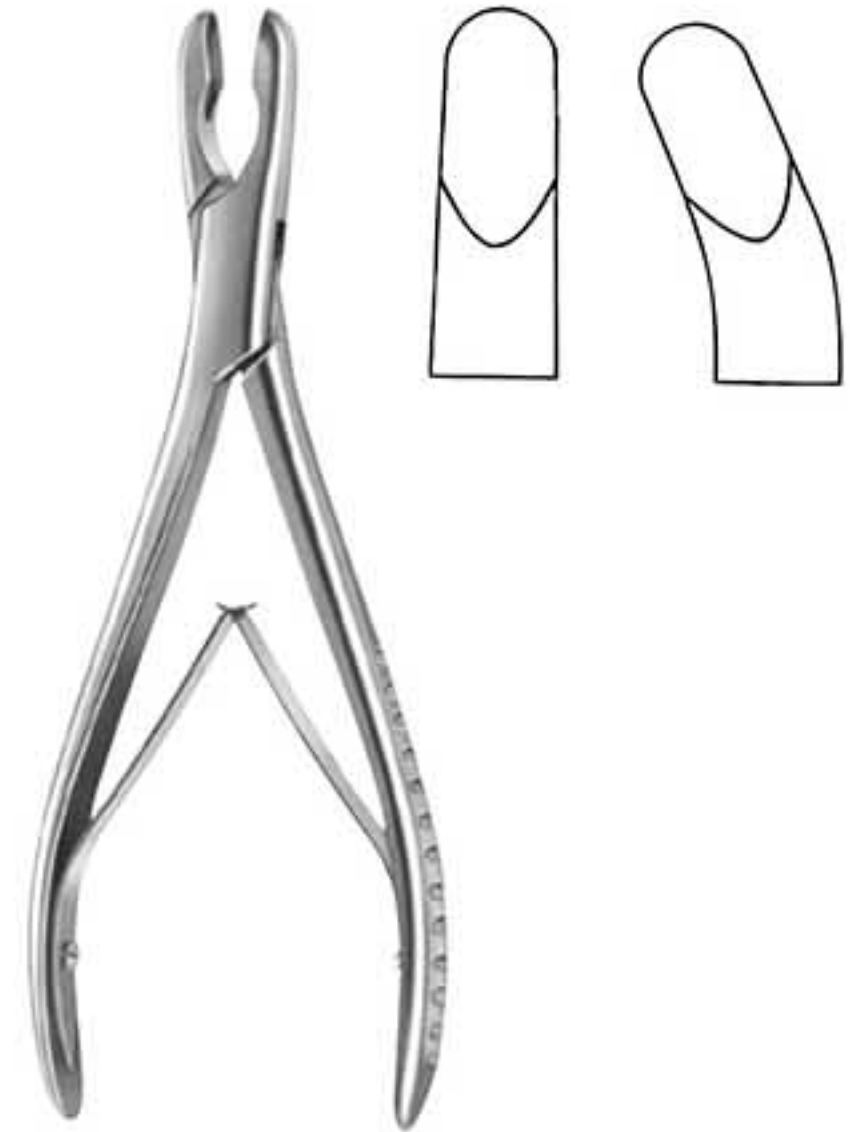

Luer Bone Rongeur
60-1748 to 60-1749

60-1748 - 7.00" 8mm x 10mm Straight
60-1749 - 7.00" 8mm x 10mm Curved

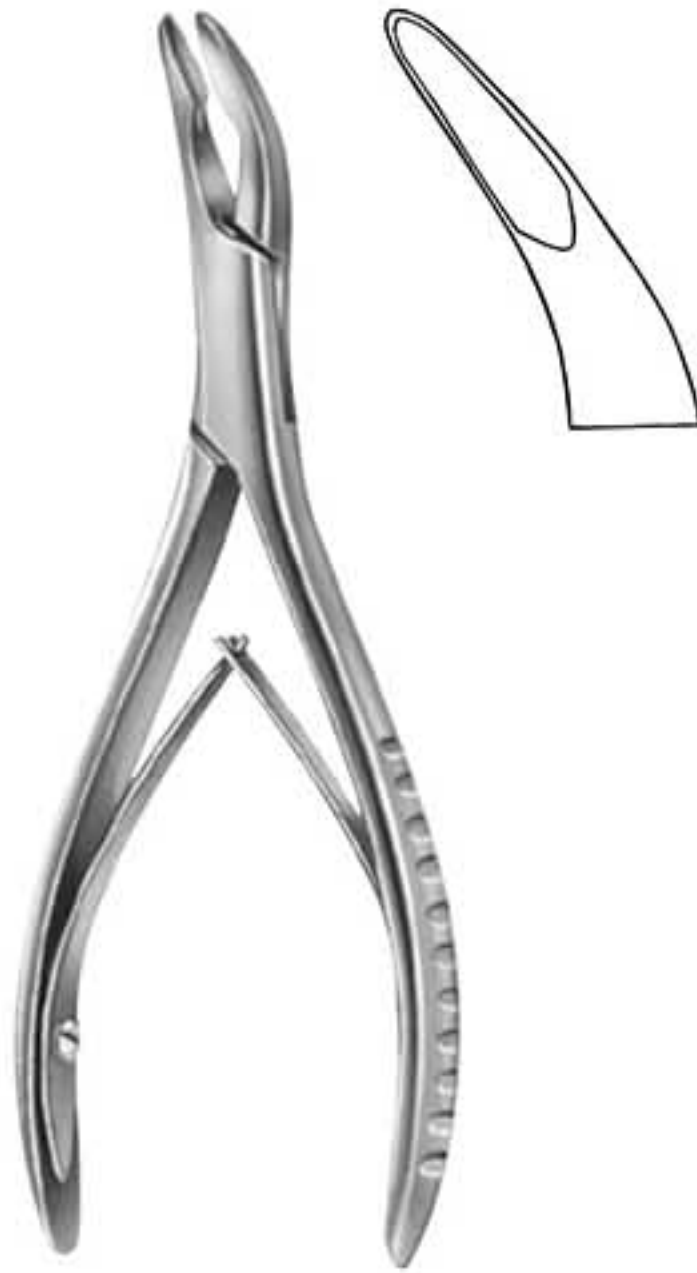

Cicherelli Rongeur

61-1750

61-1750 - 6.50"



Olivecrona Rongeur

61-1751

61-1751 - 7.50"



Bacon Bone Rongeur

61-1752

61-1752 - 8.00" 5 x 15 mm Bile Curved on Side



Adson Rongeur

61-1753

61-1753 - 8.00"



Bane Rongeur

61-1754

61-1754 - 7.00" 3 x 16 mm Bile Curved



Hartmann Rongeur

61-1755

61-1755 - 5.75" 4 x 16 mm Bile F. Curved



Beyer Rongeur
62-1756

62-1756 - 7.00"



Friedman Bone Rongeur

62-1757 to 62-1758

62-1757 - 5.50" Curved
62-1758 - 6.50" Curved



Blumenthal Rongeur

62-1759 to 62-1761

62-1759 - 6.00" 30 Angle (A)
62-1760 - 6.00" 45 Angle (B)
62-1761 - 6.00" 90 Angle (C)



Mead Rongeur

62-1762

62-1762 - 6.50" Curved 4 x13 mm Bite

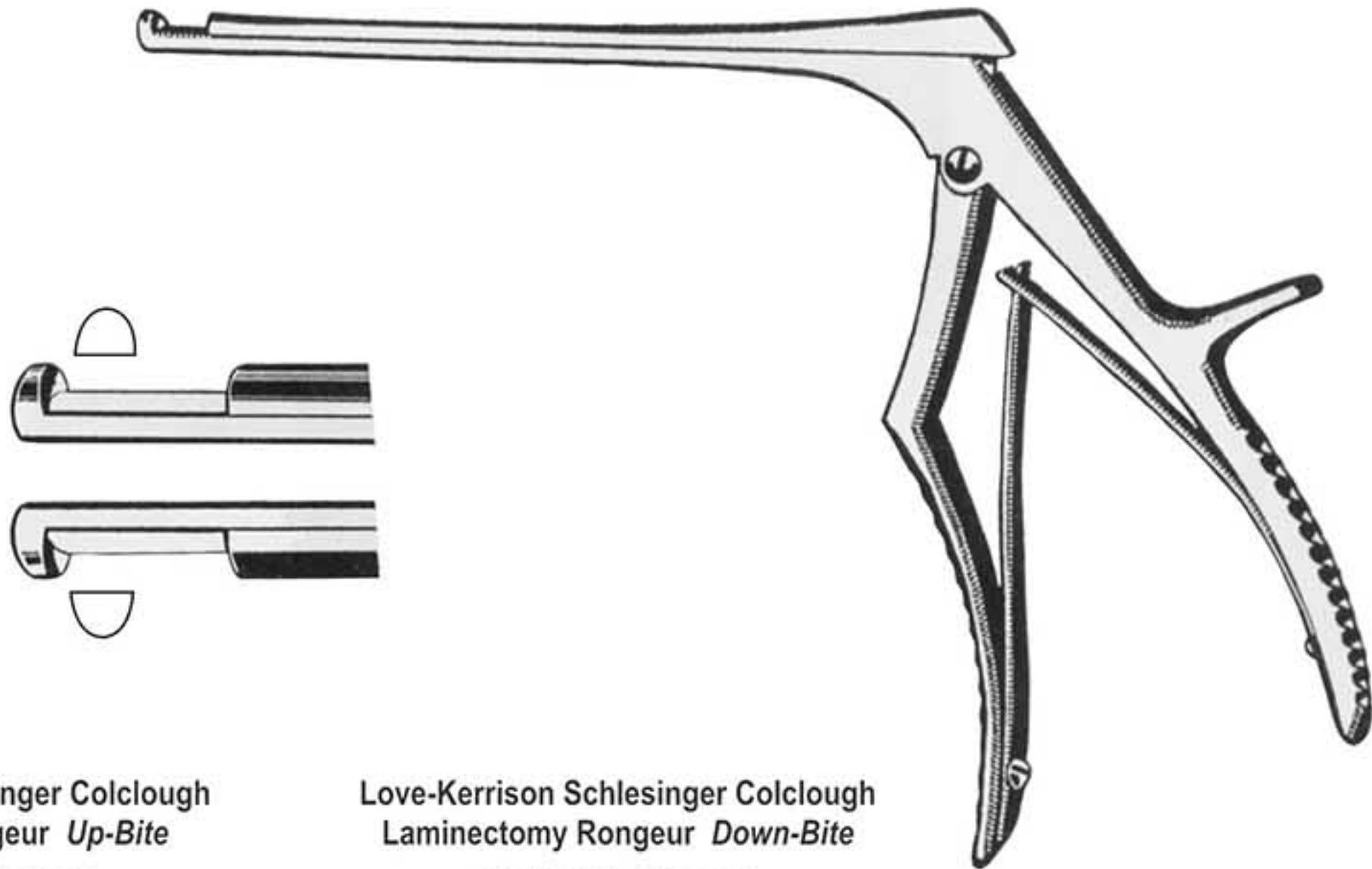

Love-Kerrison Schlessinger Colclough Laminectomy Rongeur Up-Bite

62-1763 to 62-1768

62-1763 - 6.00" Shaft 3 mm Bite
62-1764 - 6.00" Shaft 4 mm Bite
62-1765 - 6.00" Shaft 5 mm Bite
62-1766 - 8.00" Shaft 3 mm Bite
62-1767 - 8.00" Shaft 4 mm Bite
62-1768 - 8.00" Shaft 5 mm Bite

Love-Kerrison Schlessinger Colclough Laminectomy Rongeur Down-Bite

62-1769 to 62-1774

62-1769 - 6.00" Shaft 3 mm Bite
62-1770 - 6.00" Shaft 4 mm Bite
62-1771 - 6.00" Shaft 5 mm Bite
62-1772 - 8.00" Shaft 3 mm Bite
62-1773 - 8.00" Shaft 4 mm Bite
62-1774 - 8.00" Shaft 5 mm Bite

A TRADITION OF QUALITY A PROMISE OF VALUE.



Mini Blumenthal Rongeur
63-1775

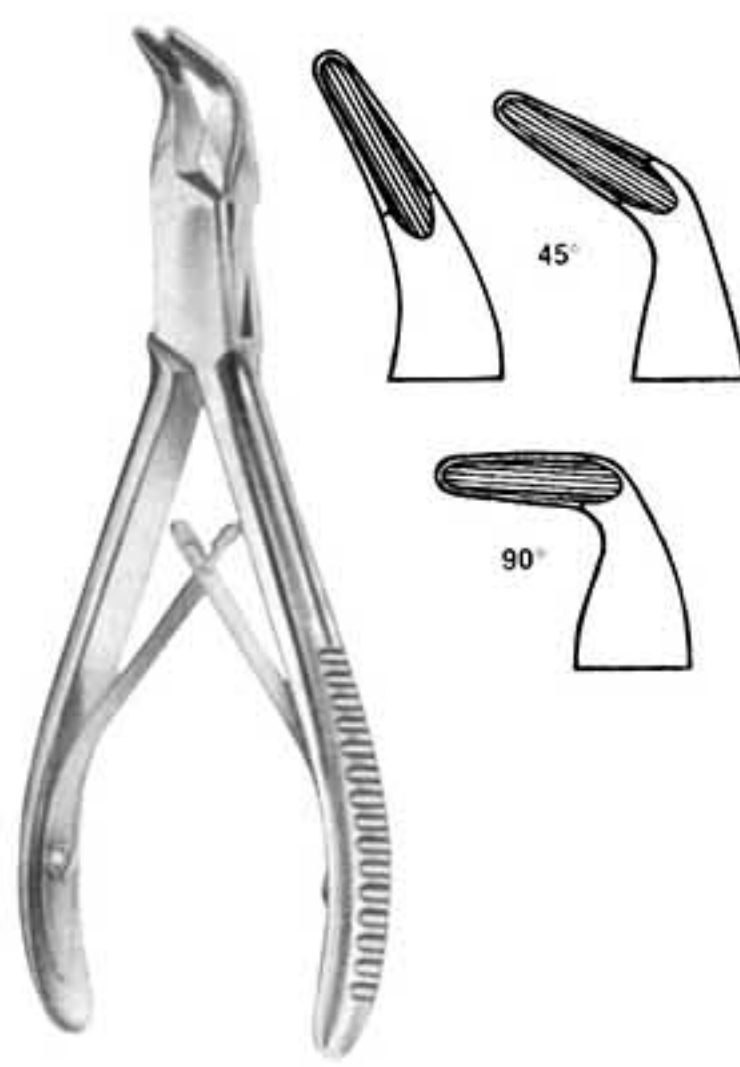

Blumenthal Rongeur
63-1776 to 63-1778



Lempert Rongeur
63-1779 to 63-1780



Stille-Luer Rongeur
63-1781 to 63-1782

63-1775 - 4.50" 11.50 cm

 63-1776 - 6.00" 15.2 cm 30° angle
 63-1777 - 6.00" 15.2 cm 45° angle
 63-1778 - 6.00" 15.2 cm 46° angle

 63-1779 - 6.25" 2.5 cm Straight
 63-1780 - 6.25" 2.5 cm Curved

 63-1781 - 8.50" Straight (A)
 63-1782 - 8.50" Curved (B)



Stille-Luer Duekbill Rongeur
63-1783

 63-1783-9.00"
 6 x 12 mm Angle to Side

Zauful Jansen Rongeur
63-1784

 63-1784-7.00"
 5 x 15 mm Curved Bite

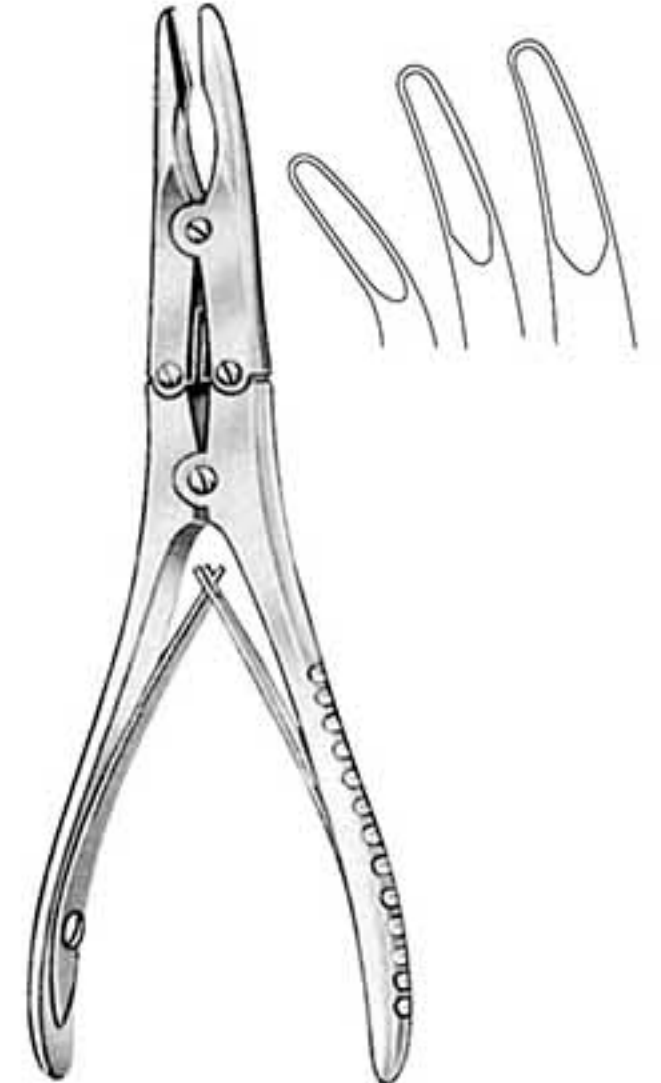
Ruskin Rongeur
63-1785 to 63-1788

 63-1785-6.00" Straight 2mm Bite
 63-1786-6.00" Curved 2mm Bite
 63-1787-7.25" Straight 5mm Bite
 63-1788-7.25" Curved 5mm Bite

Kleinert-Kutz Rongeur
63-1789 to 63-1791

 63-1789-6.00" Straight Cvd 2 x 13 Bite
 63-1790-6.00" Curved 3 x 8 Bite
 63-1791-6.00" Full Curved 3 x 16 Bite

A TRADITION OF QUALITY A PROMISE OF VALUE.



Dale First Rib Rongeur
64-1792

64-1792-14.00" 3 mm Bite



Lempert Rongeur
64-1793 to 64-1796

64-1793-6.25" Straight
64-1794-6.25" Curved
64-1795-7.50" Straight
64-1796-7.50" Curved



Lowman Clamp
64-1797 to 64-1799

64-1797-1x1 Prong 4.75x0.75 Jaw
64-1798-1x1 Prong 7.25x1.25 Jaw
64-1799-1x1 Prong 8.00x1.50 Jaw



Lambotte Bone Holding Forceps
64-1800 To 64-1802

64-1800- 8.50"
64-1801-10.50"
64-1802-12.50"



Farabeuf Bone Forceps
64-1803

64-1803-10.50"



Farabeuf-Lambotte Bone Forceps
64-1804

64-1804-10.50"



Ferguson Bone Holding Forceps
64-1805

64-1805-8.50"



Lane Bone Holding Forceps
64-1806 to 64-1807

64-1806-13.00"
64-1807-17.00"

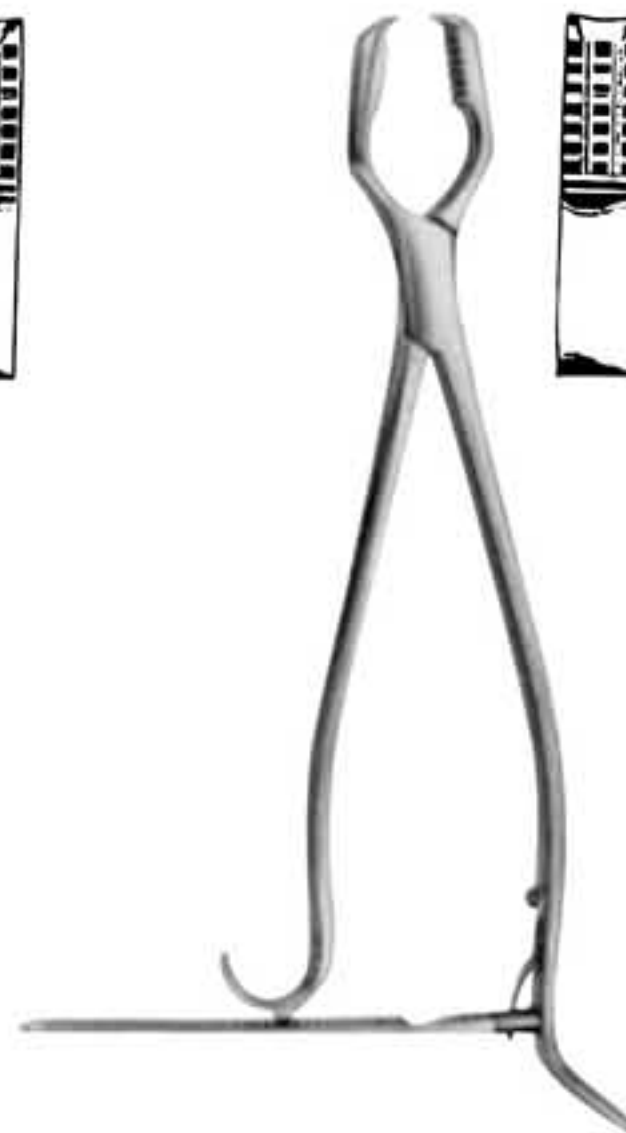

Lane Bone Holding Forceps
64-1808 to 64-1809

64-1808-13.00" W/Ratchet
64-1809-17.00" W/Ratchet



Kern Bone Holding Forceps
64-1810 to 64-1811

64-1810-5.75" Small
64-1811-8.50"



Needle Nose Pliers (round tip)
64A-2050

5 1/2" Cross Serrated



Needle Nose Pliers (flat tip)
64A-2051

5 1/2" Serrated



Nabatoff vein stripper

64A-2053

Varicosevein probe set complete



Connulated pin and wire cutter
64A-2054

64A-2054 7 1/2" (19cm)



Connulated pin and wire cutter
64A-2055 TC

64A-2055 TC 7 1/2" (19cm)



Front Side pin and wire cutter
64A-2056 - 64A-2059 TC

64A-2056 TC 7" 18cm
64A-2057 TC 9" 22cm



Double Action wire cutter
64A-2061 - 64A-2060 TC

64A-2060 TC 7" 18cm
64A-2061 TC 9" 22cm
Angled

A TRADITION OF QUALITY A PROMISE OF VALUE.

Kern Bone Holding Forceps

65-1812 to 1813

 65-1812-5.75" W/Ratchett
 65-1813- 8.50" W/Ratchett

Semb Bone Holding Forceps

65-1814

65-1814-7.50"

Lagenbeck Bone Holding Forceps

65-1815

65-1815-8.00"

Van Buren Sequestrum Forceps

65-1816

 65-1816-8.50"
 Curved

Volkman Hook

65-1817

 65-1817-8.00"
 Sharp

Hohmann Bone Elevator

65-1818 to 65-1821

 65-1818-9.00x18mm
 65-1819-9.50x20mm
 65-1820-9.50x24mm
 65-1821-9.50x43mm

Blount Single Prong Retractor

65-1822

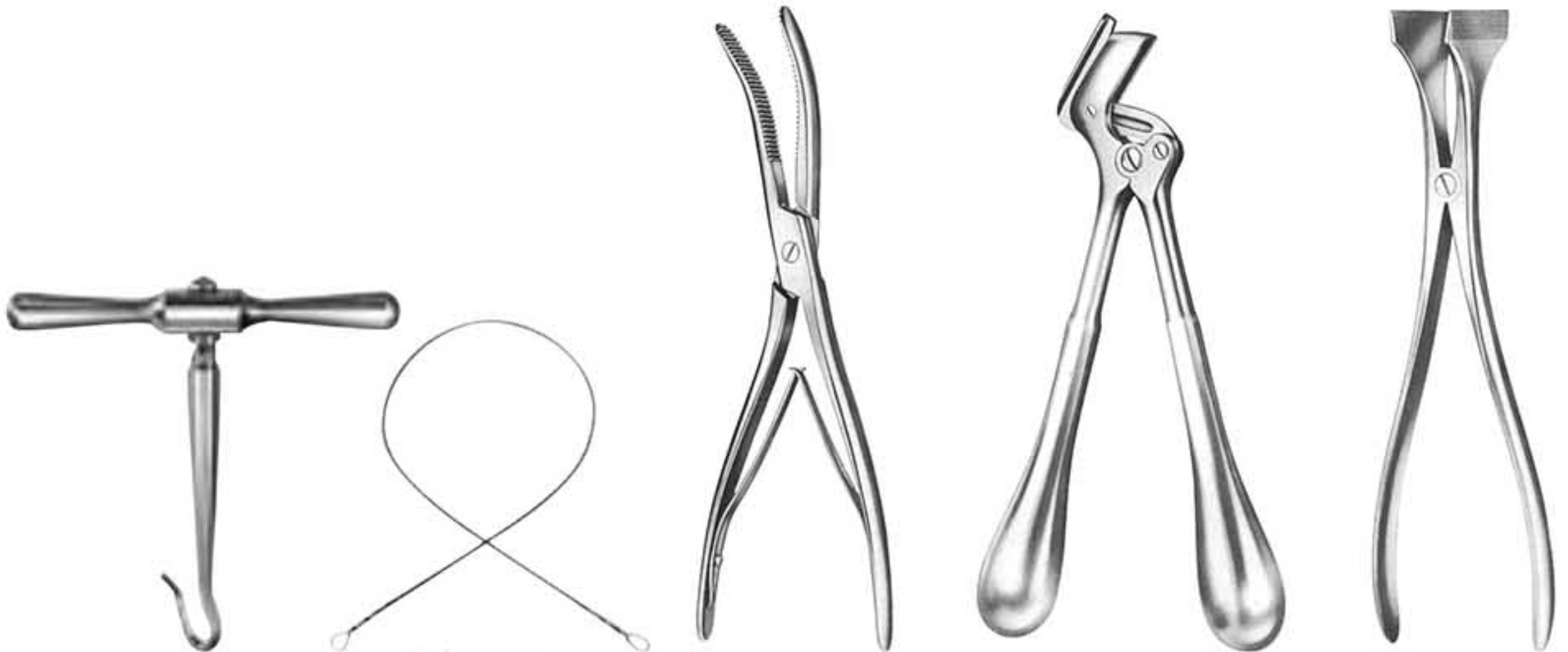
 65-1822-10.50"
 37 mm Blade Width

Gigli Saw Handle

65-1823

Gigli Saw Wires

65-1824 to 65-1827

 65-1824-09.00"
 65-1825-12.00"
 65-1826-20.00"
 65-1827-30.00"

Wolfe-Boehler Cast Breaker

65-1828

65-1828-10.00"

Stille Plaster Shears

65-1829 to 65-1830

 65-1829-10.00"
 65-1830-15.00"

Hennig Plaster Spreader

65-1831

65-1831-11.00"

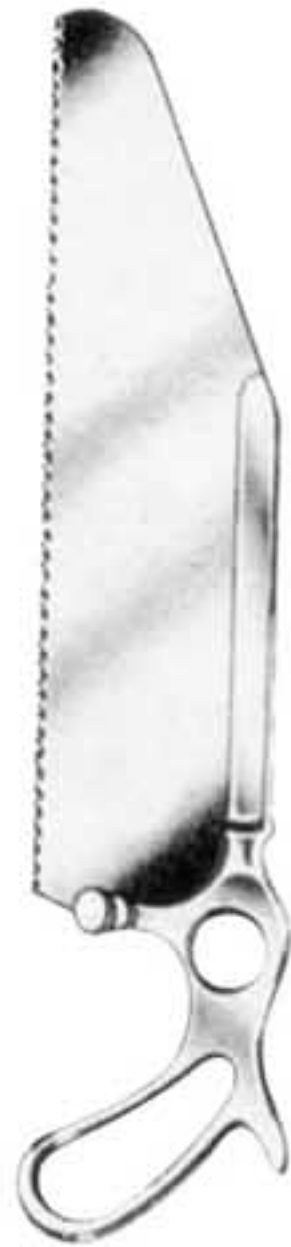

Satterlee Bone Saw
65A-2020
65A-2020-12"



Engel Cast Saw
65A-2021
65A-2021-6"

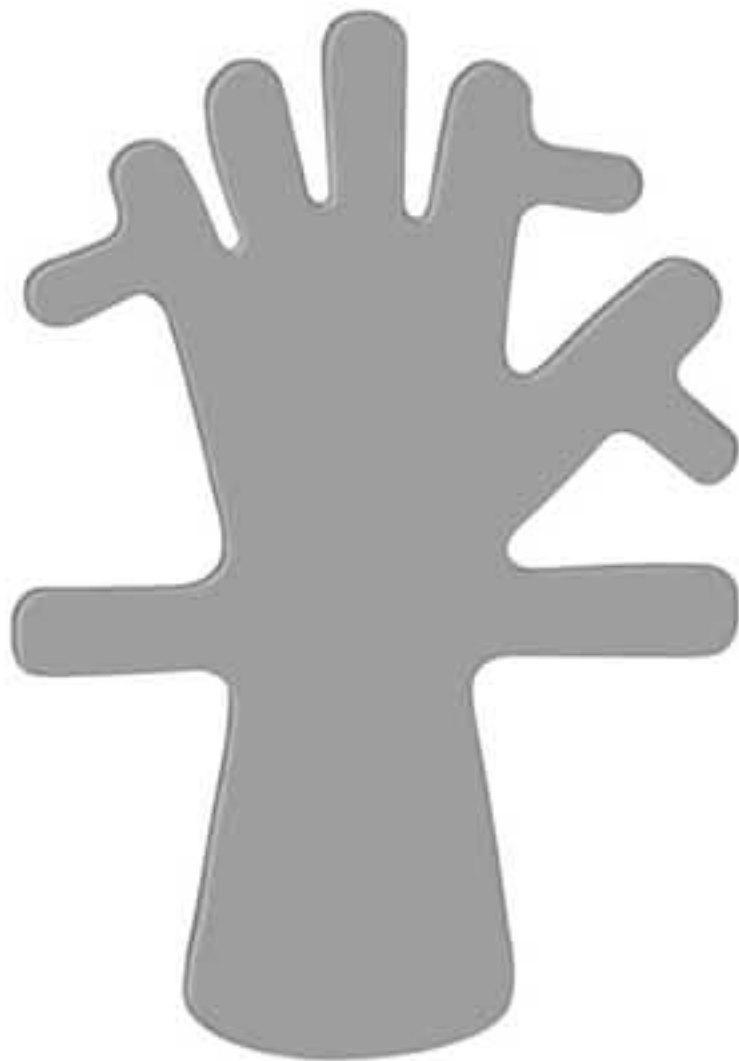

Lead Hand
65A-2022 - 65A-2024
65A-2022 Small
65A-2023 Medium
65A-2024 Large



100-358-06
Small, width 6 mm
short, narrow tip

Mini Hohmann Retractor
65A-2025
65A-2025-6"
6 mm wide
short, narrow tip



100-360-08
Small, width 8 mm
short, narrow tip

Mini Hohmann Retractor
65A-2026
65A-2026-6"
8 mm wide
short, narrow tip

A TRADITION OF QUALITY A PROMISE OF VALUE.

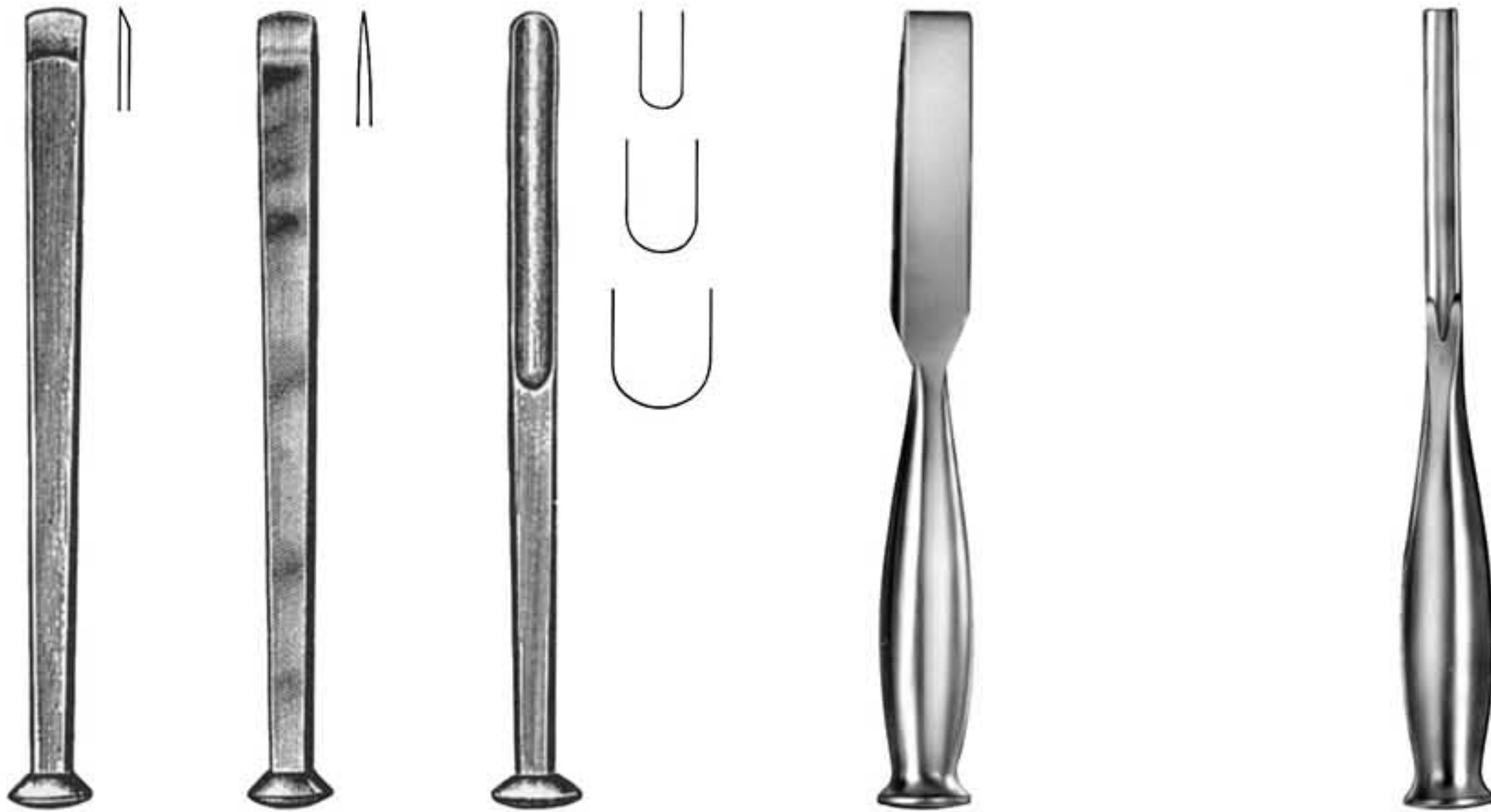
Army Pattern Chisel

66-1832 to 66-1834

Army Pattern Osteotome

66-1835 to 66-1837

Army Pattern Gouge

66-1838 to 66-1840

Smith Peterson Osteotome

66-1841 to 66-1847 Str. 66-1848 to 66-1854 Cvd.

Smith Peterson Gouge

66-1855 to 66-1861 Str. 66-1862 to 66-1868 Cvd.

66-1832-6.50" 6 mm	66-1835-6.50" 6 mm	66-1838-6.50" 6 mm	66-1841-8.00" 0.6cm Str.	66-1848-8.00" 0.6cm Cvd.	66-1855-8.00" 0.6cm Str.	66-1862-8.00" 0.6cm Cvd.
66-1832-6.50" 8 mm	66-1835-6.50" 8 mm	66-1838-6.50" 8 mm	66-1842-8.00" 1.0cm Str.	66-1849-8.00" 1.0cm Cvd.	66-1856-8.00" 1.0cm Str.	66-1863-8.00" 1.0cm Cvd.
66-1832-6.50" 10 mm	66-1835-6.50" 10 mm	66-1839-6.50" 10 mm	66-1843-8.00" 1.3cm Str.	66-1850-8.00" 1.3cm Cvd.	66-1857-8.00" 1.3cm Str.	66-1864-8.00" 1.3cm Cvd.
66-1833-6.50" 12 mm	66-1836-6.50" 12 mm	66-1839-6.50" 12 mm	66-1844-8.00" 1.6cm Str.	66-1851-8.00" 1.6cm Cvd.	66-1858-8.00" 1.6cm Str.	66-1865-8.00" 1.6cm Cvd.
66-1833-6.50" 14 mm	66-1836-6.50" 14 mm	66-1840-6.50" 14 mm	66-1845-8.00" 1.9cm Str.	66-1852-8.00" 1.9cm Cvd.	66-1859-8.00" 1.9cm Str.	66-1866-8.00" 1.9cm Cvd.
66-1833-6.50" 16 mm	66-1836-6.50" 16 mm	66-1840-6.50" 16 mm	66-1846-8.00" 2.5cm Str.	66-1853-8.00" 2.5cm Cvd.	66-1860-8.00" 2.5cm Str.	66-1867-8.00" 2.5cm Cvd.
66-1834-6.50" 18 mm	66-1837-6.50" 18 mm		66-1847-8.00" 4.1cm Str.	66-1854-8.00" 4.1cm Cvd.	66-1861-8.00" 4.1cm Str.	66-1868-8.00" 4.1cm Cvd.

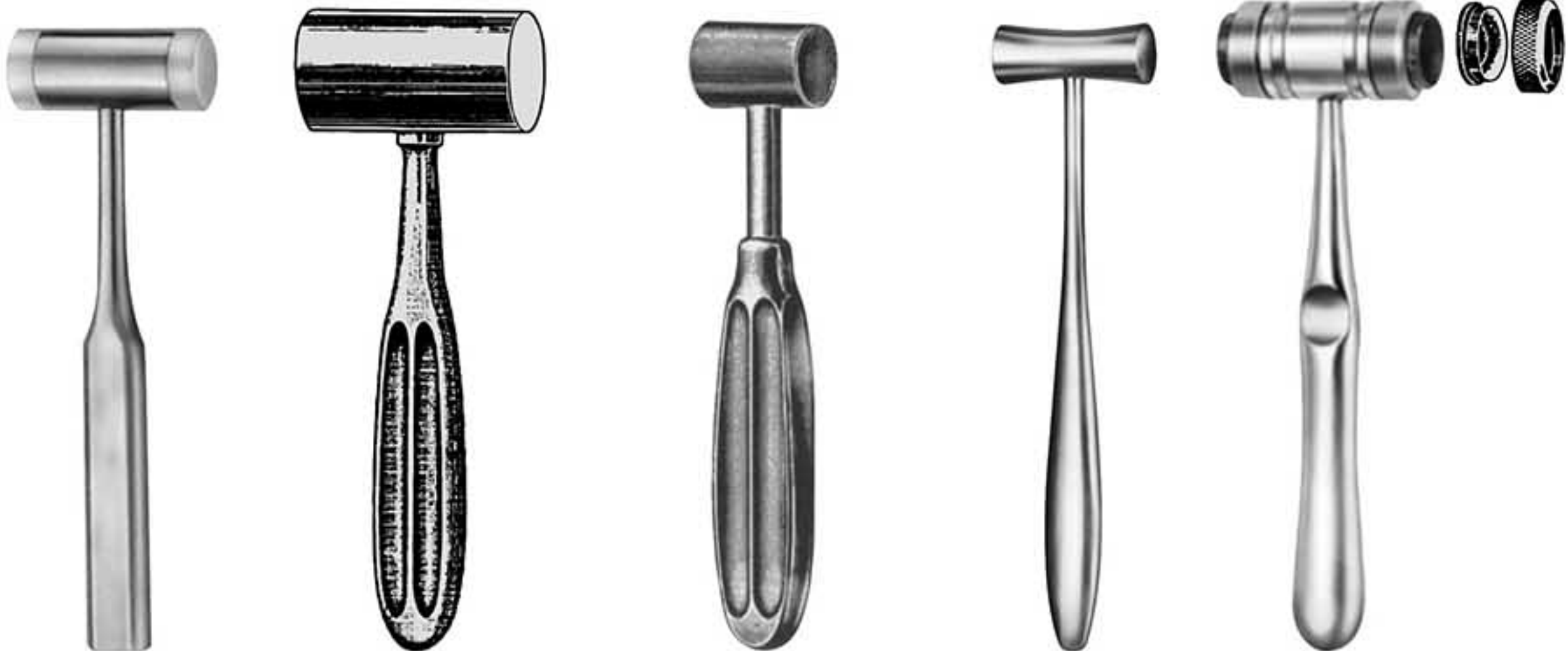
Mallet With Two Plastic Ends

66-1869

Kirk Bone Mallet

66-1870

Gerzog Bone Mallet

66-1871

Lucae Mallet

66-1872

Mead Mallet

66-1873

66-1870-7.25" 1.50 Diameter

66-1871-7.50" 1.00 Diameter

66-1872-7.50" 1.00 Diameter

W / Replacement Plastic Discs Round Surface



Cooley Rib Retractor	Cooley Rib Retractor	Cooley Rib Retractor	Finochietto Retractor	Tuffier Rib Retractor
66A-2030	66A-2031	66A-2032	66A-2033	66A-2034
Lateral blades 12 x 16mm, Spreading 300mm	Lateral blades 15 x 30mm, Spreading 140mm	Lateral blades 35 x 50mm, Spreading 300mm	Lateral blades 15 x 15mm, Spreading 75mm	Lateral blades 45 x 45mm, Spreading 160mm



**Baby Finochietto
Rib Retractor**
66A-2035

66A-2035 (3")
18mm x 20mm x 75mm
spread

**Finochietto
Rib Spreader**
66A-2036

66A-2036 (7 3/4")
46mm x 55mm x 200mm
spread

**Burford-Finichietto
Rib Spreader**
66A-2037

66A-2037 (7")
spread with 2 sets of blade
65mm x 62mm
47mm x 62mm
08" 10" 12" Spread

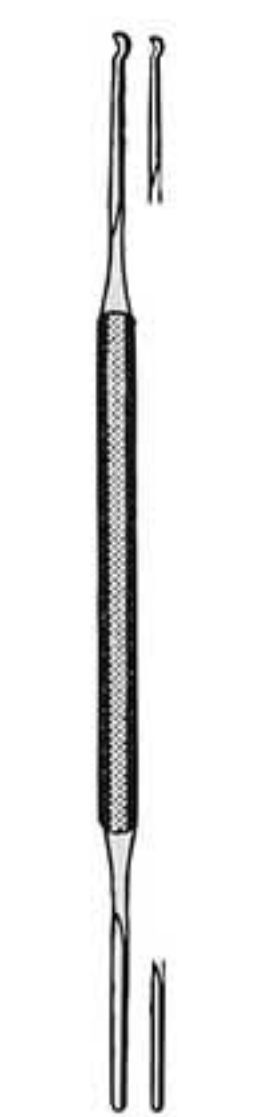
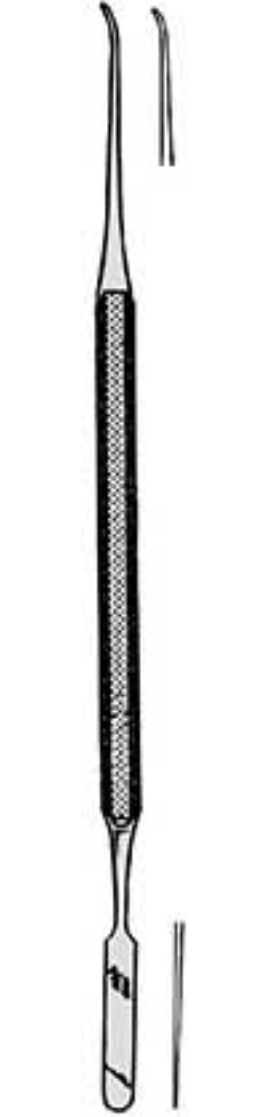
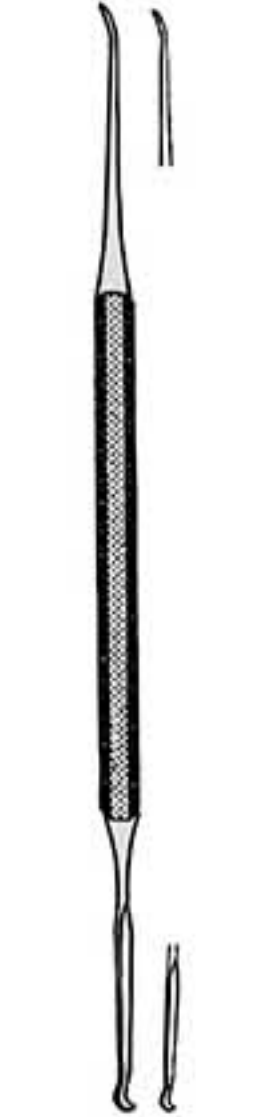

Lewis Rasp
67-1874 to 67-1875
67-1874-7.00" Fine
67-1875-8.00" Coarse

Cottle Rasp
67-1876
67-1876-8.00"

Excavator & Packer
67-1877
67-1877 - 6.00"
D / Ended

Probe & Spatula
67-1878
67-1878 - 6.00"

Excavator & Packer
67-1879
67-1879-5.75"
D / Ended

Spatula Round Ended
67-1880
67-1880 - 6mm

Spatula Round Ended
67-1881
67-1881 - 7mm

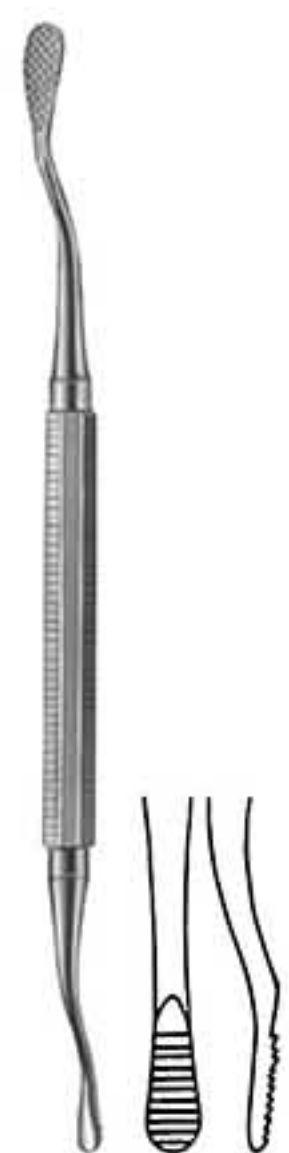
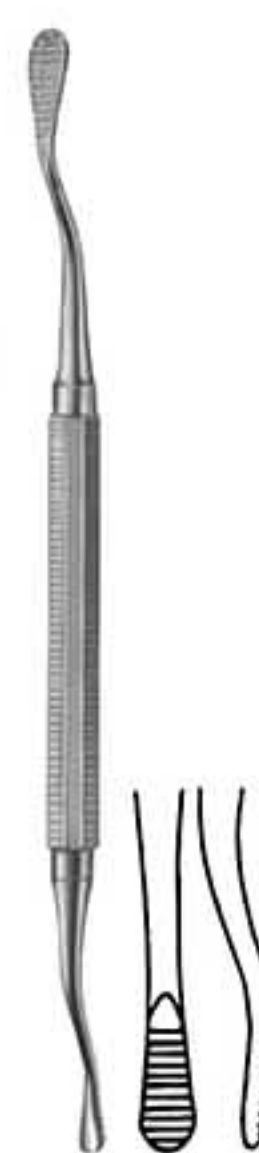
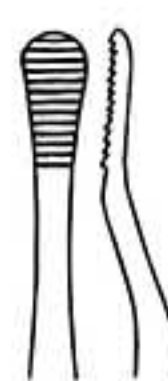
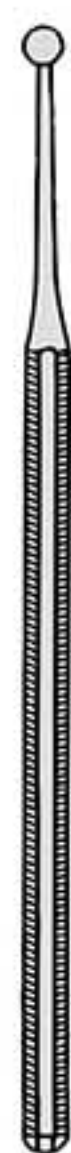

Curette-Excavator Single End With Hole
67-1882 to 67-1885
67-1882-5.50" 1.0 mm
67-1883-5.50" 1.5 mm
67-1884-5.50" 2.0 mm
67-1885-5.50" 2.5 mm

Curette-Excavator Single End Without Hole
67-1886 to 67-1889
67-1886-5.50" 1.0 mm
67-1887-5.50" 1.5 mm
67-1888-5.50" 2.0 mm
67-1889-5.50" 2.5 mm

Verucca Curette
67-1890
67-1890 - 4mm

Bone File #12
67-1891
67-1891 - 7.00"
Both Ended

Bone File #12 A
67-1892
67-1892 - 7.00"
Both Ended

A TRADITION OF QUALITY A PROMISE OF VALUE.

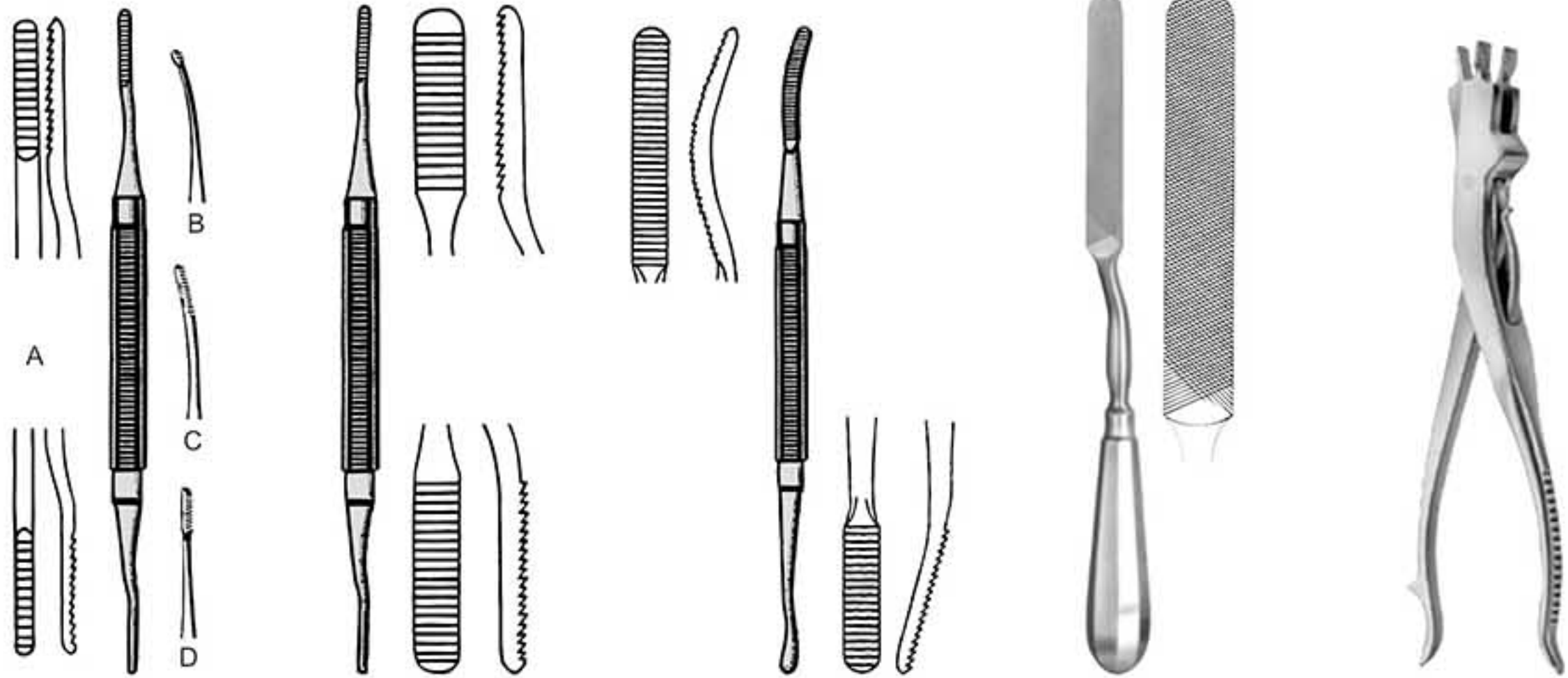
Nail & Bone Rasp
 68-61893A to 68-1896D

Nail & Bone Rasp
 68-1897

Bone Rasp # 10
 68-1898

Bayonet Bone File
 68-1899

3-Prong Cast Spreader
 68-1900

 68-1893 A - 7.00" 3mm x4mm D/Ended
 68-1894 B - 6.00" 3mm x4mm Single Ended
 68-1895 C - 6.50" 3mm x4mm Single Ended
 68-1896 D - 6.25" 1.3mm Straight

 68-1897 - 8.50"
 Plain Serrations

 68-1898 - 7.00"
 D/Ended Curved &
 Flats Ends

68-1899 - 9½"

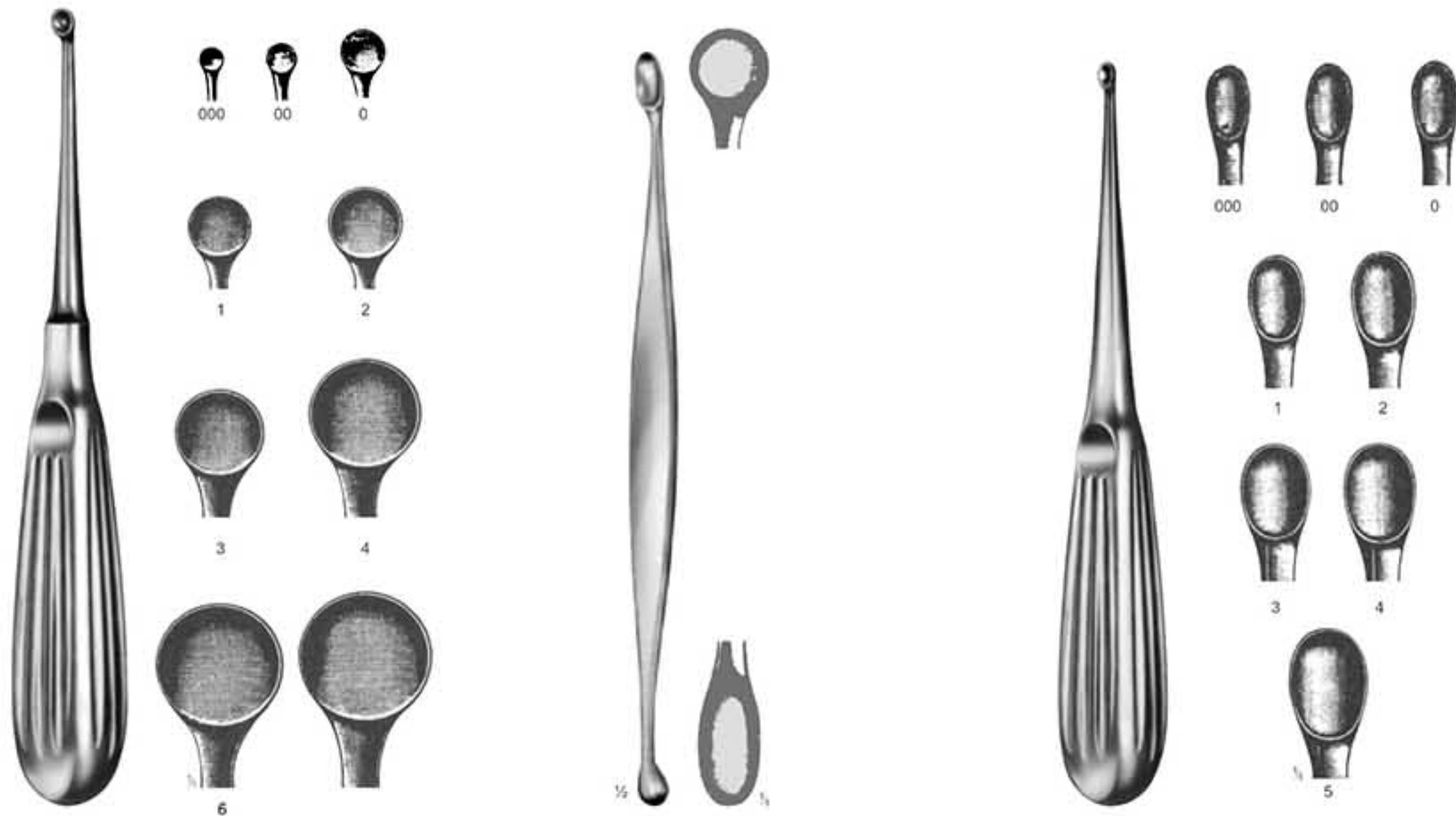
 68-1900 - 9.00"
 With Spring Action
 for one-Handed Operation

Bruns Curette / Round Shape
 68-1901 to 68-1909

Bruns Curette
 68-1910 to 68-1911

Bruns Curette / Oval Shape
 68-1912 to 68-1919

 68-1901 #000, 6 3/4" 68-1906 #3, 6 3/4"
 68-1902 #00, 6 3/4" 68-1907 #4, 6 3/4"
 68-1903 #0, 6 3/4" 68-1908 #5, 6 3/4"
 68-1904 #1, 6 3/4" 68-1909 #6, 6 3/4"
 68-1905 #2, 6 3/4"

 68-1910 Double Ended, 5.00"
 68-1911 Double Ended, 6½"

 68-1912 #000, 8.00" 68-1916 #3, 8.00"
 68-1913 #00, 8.00" 68-1917 #4, 8.00"
 68-1914 #0, 8.00" 68-1918 #5, 8.00"
 68-1915 #1, 8.00" 68-1919 #6, 8.00"
 68-1916 #2, 8.00"

Hand Surgery, Ophtalmology, Plastic Surgery, Experimental Surgery



69-3001	69-3002	69-3003	69-3004	69-3005	69-3006
Size: 4½"	Size: 4½"	Size: 4½"	Size: 4½" 45°	Size: 4½" 45°	Size: 4½" 45°

Microsurgery, ENT



69-3012	69-3013
Size: 6½"	Size: 6½"

Microsurgery, ENT



69-3007	69-3008	69-3009	69-3010	69-3011
Size: 6½"	Size: 6½"	Size: 6½" 1 mm	Size: 6½"	Size: 6½" 1 mm

Gynaecology, ENT, Tonsil Surgery



69-3014	69-3015
Size: 7 1/4"	Size: 7 1/4" 1 mm

Microsurgery, ENT
Neurosurgery

70-3016

70-3017

70-3018

70-3021

70-3022

70-3023

70-3024

Size: 6½"

Size: 6½"

 Size: 6½"
1 mm

Size: 6½"

 Size: 6½"
1 mm

 Size: 6½"
2 mm

 Size: 6½"
1 mm

 70-3026
Size: 0.3 mm

 70-3027
Size: 0.3 mm

 70-3028
Size: 1.2 mm

70-3019

70-3020

70-3025

70-3029

 Size: 7 1/4"
1 mm

 Size: 7 1/4"
1 mm

 Size: 7 1/4"
1 mm

 Size: 6½"
1 mm

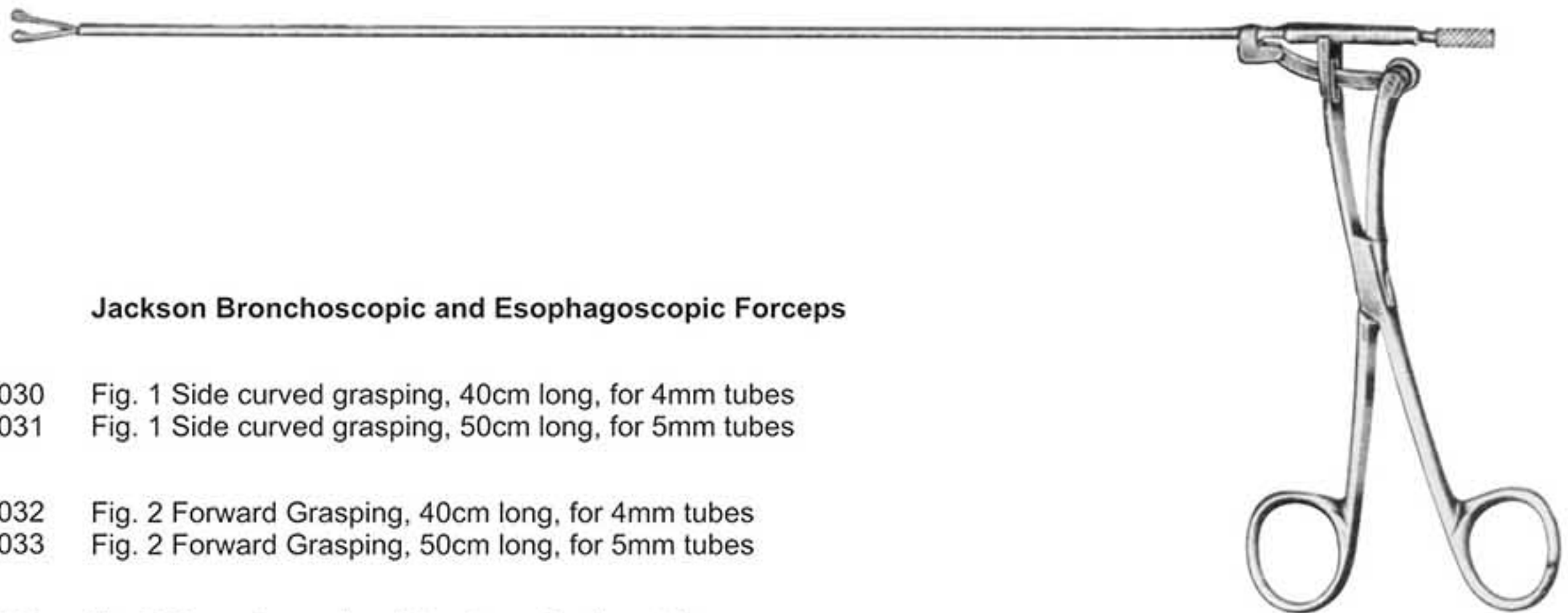
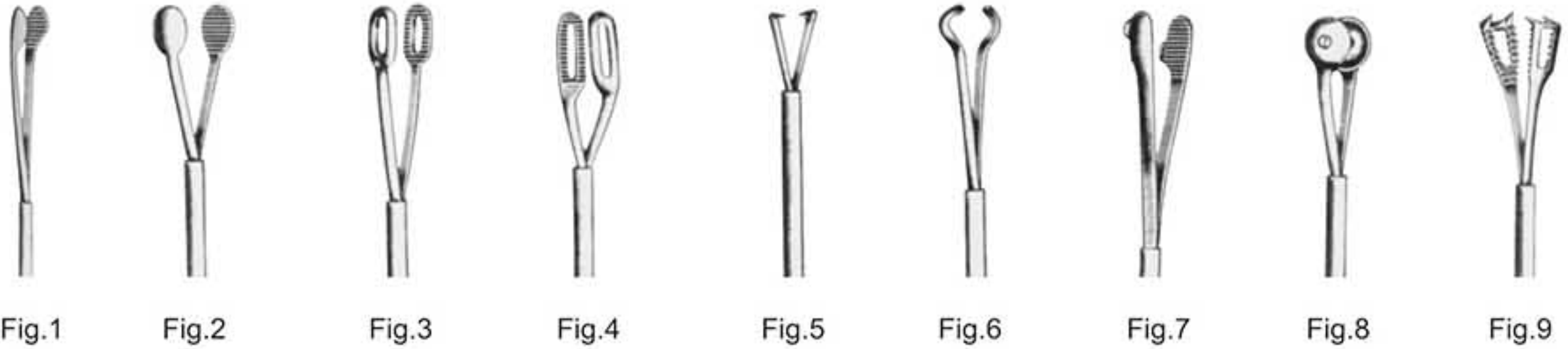

Jackson Bronchoscopic and Esophagosopic Forceps

- 71-3030 Fig. 1 Side curved grasping, 40cm long, for 4mm tubes
- 71-3031 Fig. 1 Side curved grasping, 50cm long, for 5mm tubes

- 71-3032 Fig. 2 Forward Grasping, 40cm long, for 4mm tubes
- 71-3033 Fig. 2 Forward Grasping, 50cm long, for 5mm tubes

- 71-3034 Fig. 3 Peanut grasping, 40cm long, for 4mm tubes
- 71-3035 Fig. 3 Peanut grasping, 50cm long, for 5mm tubes

- 71-3036 Fig. 4 Meat Grasping, 50cm long, for 7mm tubes

- 71-3037 Fig. 5 Sharp pointed, right angle rotating, 35cm long, for 3.5mm tubes
- 71-3038 Fig. 5 Sharp pointed, right angle rotating, 50cm long, for 5mm tubes

- 71-3039 Fig. 6 Dull pointed, right angle rotating, 40cm long, for 4mm tubes
- 71-3040 Fig. 6 Dull pointed, right angle rotating, 50cm long, for 5mm tubes

- 71-3041 Fig. 7 Tack and pin, 40cmlong, for 4mm tubes
- 71-3042 Fig. 7 Tack and pin, 50cmlong, for 5mm tubes

- 71-3043 Fig. 8 Globular objects, 35cm long, for 3.5cm tubes
- 71-3044 Fig. 8 Globular objects, 40cm long, for 4cm tubes
- 71-3045 Fig. 8 Globular objects, 50cm long, for 8cm tubes

- 71-3046 Fig. 9 Double prong grasping, 50cm long, for 5mm tubes

 72-3047
 72-3048

72-3049



72-3050

 72-3051
 to
 72-3055

72-3056

 72-3057
 to
 72-3060

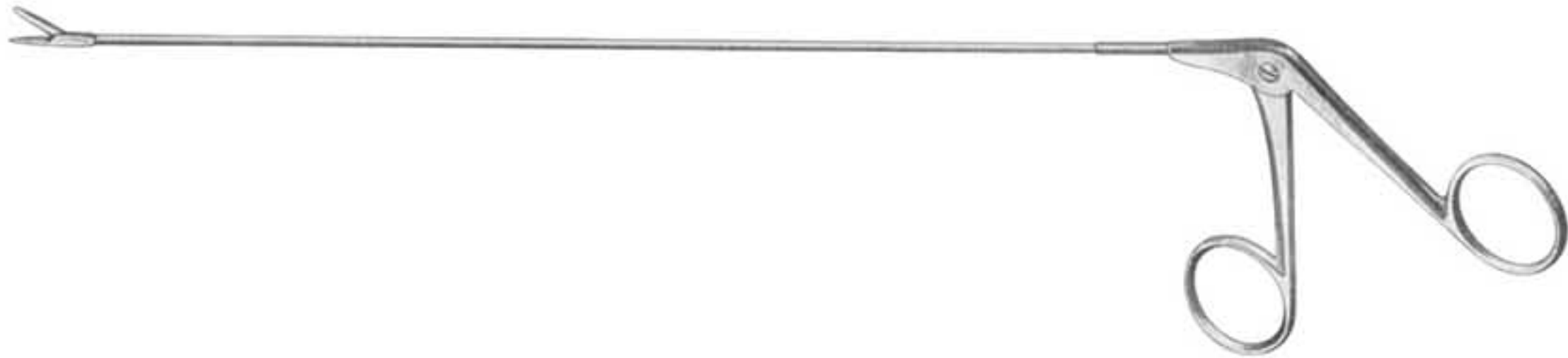
 72-3061
 72-3062

Bronchoscopic Forceps Double Articulated Jaws

72-3047 to 72-3062

- 72-3047 Serrated Grasping Jaws, 30cm shaft, 4mm pass diameter
 72-3048 Serrated Grasping Jaws, 50cm shaft, 4mm pass diameter
- 72-3049 Kahler Alligator Grasping Jaws, 40mm shaft, 4mm pass diameter
- 72-3050 Circular Cup Biopsy Jaws, 4mm dia., 50cm shaft, 5mm pass diameter
 Standard Alligator Jaws
- 72-3051 Serrated Jaws 3 x 12mm, 30cm shaft, 4mm pass diameter
 72-3052 Serrated Jaws 3 x 12mm, 40cm shaft, 4mm pass diameter
 72-3053 Serrated Jaws 3 x 12mm, 50cm shaft, 4mm pass diameter
 72-3054 Serrated Jaws 3 x 12mm, 60cm shaft, 4mm pass diameter
 72-3055 Serrated Jaws 2 x 8mm, Miniature size, 20cm shaft, 3mm pass diameter
- 72-3056 Papilloma Grasping Jaws 7mm wide, with fine serrations, 30cm shaft
- 72-3057 Jackson Cup Jaws 2mm dia. straight, 30cm shaft
 72-3058 Jackson Cup Jaws 4mm dia. straight, 30cm shaft
 72-3059 Jackson Cup Jaws 4mm dia. straight, 50cm shaft
 72-3060 Jackson Cup Jaws 4mm dia. straight, 60cm shaft
- 72-3061 Jackson Cup Jaws 4mm dia. angular, 30cm shaft
 72-3062 Jackson Cup Jaws 4mm dia. angular, 60cm shaft



Barber Scissors
73-942 to 73-948

73-942 - 4.50"
73-944 - 5.50"
73-946 - 6.50"
73-948 - 7.50"



Barber Scissors
73-936 to 73-940

73-936 - 4.50"
73-937 - 5.50"
73-938 - 6.50"
73-940 - 7.50"



Barber Scissors
73-932 to 73-934

73-932 - 5.50"
73-934 - 6.50"



Thinning Scissors
73-950

73-950 - 6.00"



Thinning Scissors
73-952

73-952 - 6.50"



Tailor Scissors
73-920 to 73-924

73-920 - 7.00" 73-923 - 10.00"
73-921 - 8.00" 73-924 - 12.00"
73-922 - 9.00"



Left Handle Tailor Scissors
73-925 to 73-929

73-925 - 7.00" 73-928 - 10.00"
73-926 - 8.00" 73-929 - 12.00"
73-927 - 9.00"



Protainer Scissors
73-930

73-930 - 8.00"



Eyebrow and Safety Tweezers

74-955 74-956 74-957 74-958 74-959 74-960 74-961 74-962 74-963 74-964 74-965 74-966



Embroidery Scissors 3 1/2"

Nail Scissors 3 1/2"

Safety Scissors 3 1/2"

74-967 74-968 74-969 74-970 74-971 74-972



Arrow Point Scissors

Cuticle Scissors

Hemo. W/Plasstic Handle

Long Nose Pliers

**Razor
w/out Blade**

**Razor
with Blade**

74-973

74-974

74-975 - 5.50" Str.
74-976 - 5.50" Cvd.
74-975A - 6.25" Str.
74-976A - 6.25" Cvd.

74-977 - 8.00"
74-978 - 8.00"

74-979

74-980



Scaler / Dental Picks
75-1101 Set 4 Pcs.

Scaler / Dental Picks
75-1102 Set 4 Pcs.

Scaler / Dental Picks
75-1103 Set 4 Pcs.

Scaler / Dental Picks
75-1104 Set 4 Pcs.



Scaler / Dental Picks
75-1105 Set 4 Pcs.

Scaler / Dental Picks
75-1106 Set 4 Pcs.

Universal Set / Tweezer Set
75-1107 Set 4 Pcs.



Iris Scissors
76-T-01

76-T-01 4.50" Straight



Iris Scissors
76-T-02

76-T-02 4.50" Curved



O.R Scissors
76-T-04 to 76-T-05

76-T-04 5.50" S/B Straight
76-T-05 5.50" S/B Curved



Metzenbaum Scissors
76-T-06 to 76-T-10

76-T-06 5.50" Straight
76-T-07 7.00" Straight
76-T-08 8.00" Straight
76-T-09 9.00" Straight
76-T-10 11.00" Straight



Strabismus Scissors
76-T-50 - 76-T-51

76-T-50 4 1/2" Straight
76-T-51 4 1/2" Curved



Metzenbaum Scissors
76-T-11 to 76-T-15

76-T-11 5.50" Curved
76-T-12 7.00" Curved
76-T-13 8.00" Curved
76-T-14 9.00" Curved
76-T-15 11.00" Curved



Mayo Dissecting Scissors
76-T-16 to 76-T-19

76-T-16 5.50" Straight
76-T-17 6.75" Straight
76-T-18 8.00" Straight
76-T-19 9.00" Straight



Mayo Dissecting Scissors
76-T-20 to 76-T-23

76-T-20 5.50" Curved
76-T-21 7.00" Curved
76-T-22 8.00" Curved
76-T-23 9.00" Curved



Rouger Wire Cutter Scissors
77-T-24

77-T-24 4.75"



Thumb Dressing Forceps
77-T-25 to 77-T-27

77-T-25 5.50"
77-T-26 6.00"
77-T-27 8.00"



Adson Forceps Serrated
77-T-27 to 77-T-30

77-T-27 4.75" Serrated
77-T-28 4.75" Fine Point
77-T-29 4.75" Brown 7x7 Teeth
77-T-30 4.75" Brown 9x9 Teeth



Mayo Hegar Needle Holder
77-T-31 to 77-T-34

77-T-31 5.50"
77-T-32 6.00"
77-T-33 7.00"
77-T-34 8.00"



Baumgartner Needle Holder
77-T-35

77-T-35 5.50"



Webster Needle Holder
77-T-36

77-T-36 5.00"
77-T-52 5 1/2"
77-T-53 6.00"

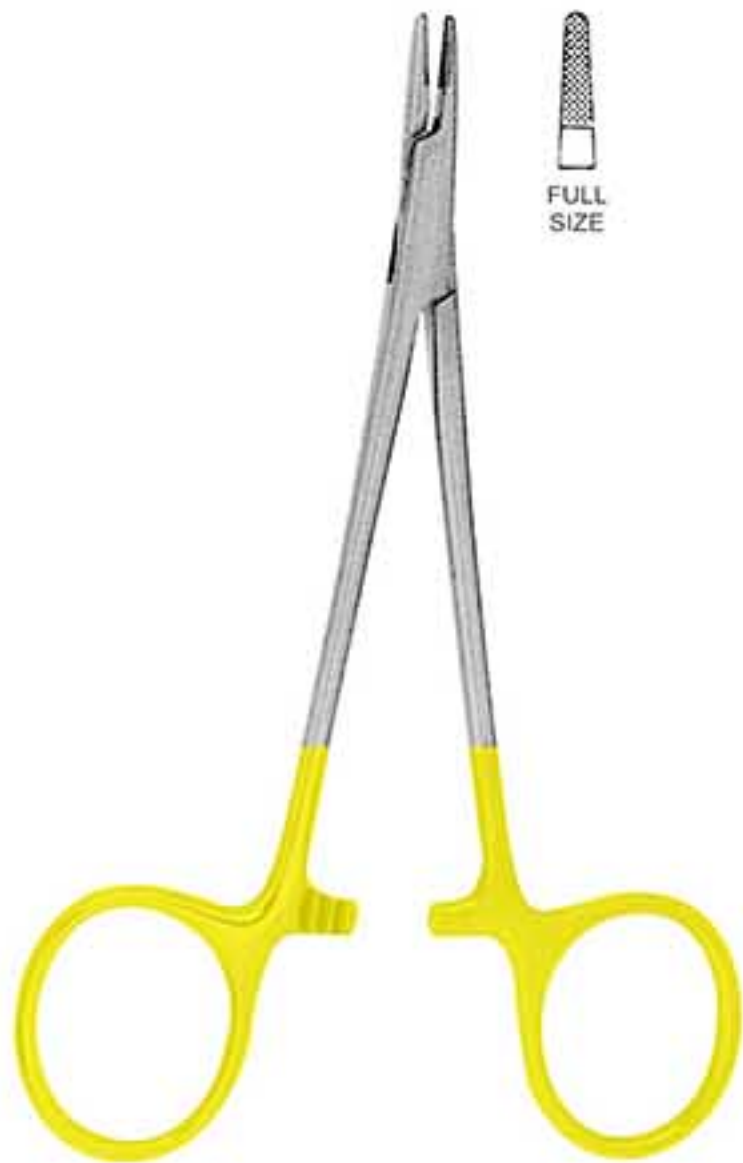

Derf Needle Holder
78-T-37

78-T-37 4.75"

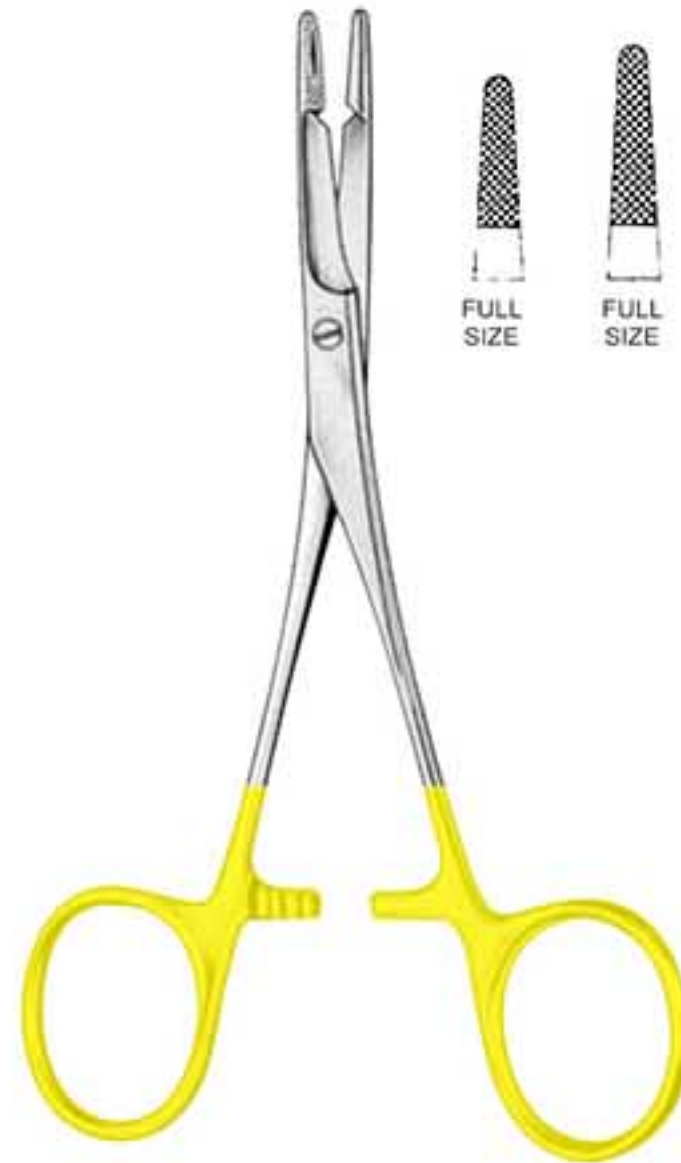

Olsen Hegar Needle Holder
78-T-38 to 78-T-40

78-T-38 5.50"
78-T-39 6.50"
78-T-40 7.50"



Cril Wood Needle Holder
78-T-41

78-T-41 6.00"

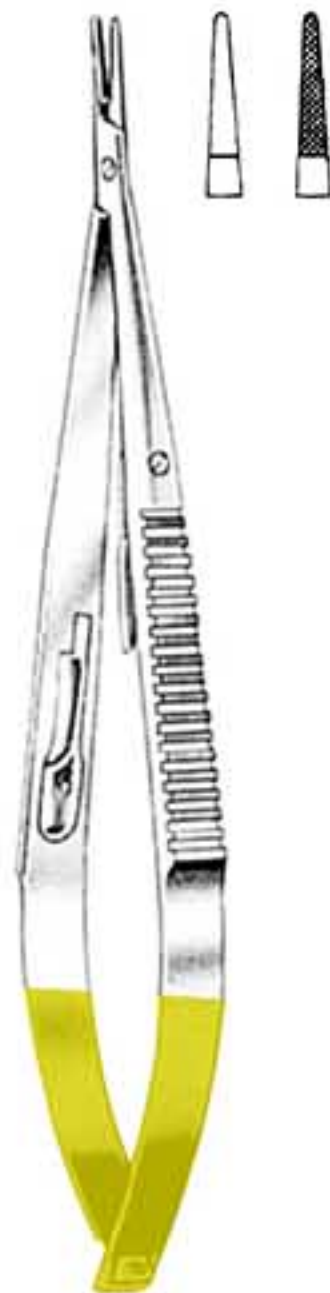

Castroviejo Needle Holder
78-T-42 to 78-T-43

78-T-42 5.50" Str.
78-T-43 5.50" Cvd.



Kalman (Ryder) Needle Holder
78-T-44 to 78-T-45

78-T-44 5.50"
78-T-45 7.00"



Super Cut O.R. Scissors
78A-SC101

78A-SC101 S/B Str. 5 1/2"



Super Cut O.R. Scissors
78A-SC102

78A-SC102 S/B Cvd. 5 1/2"



Super Cut Mayo Scissors
78A-SC103 - 78A-SC105

78A-SC103 Str. 5 1/2"
78A-SC105 Str. 6 3/4"



Super Cut Mayo Scissors
78A-SC104 - 78A-SC106

78A-SC104 Cvd. 5 1/2"
78A-SC106 Cvd. 6 3/4"



Super Cut Mayo Scissors
78A-SC107

78A-SC107 Str. 9"



Super Cut Mayo Scissors
78A-SC108

78A-SC108 Cvd. 9"



Super Cut Metzenbaum Scissors
78A-SC109

78A-SC109 Str. 5 1/2"
78A-SC111 Str. 7"



Super Cut Metzenbaum Scissors
78A-SC110 - 78A-SC112

78A-SC110 Cvd. 5 1/2"
78A-SC112 Cvd. 7"



Super Cut Metzenbaum Scissors
78A-SC113 - 78A-SC114

78A-SC113 Str. 9"
78A-SC114 Cvd. 9"



Baby Super Cut Metzenbaum Scissors		Baby Super Cut Metzenbaum Scissors		Super Cut Iris Scissors		Super Cut Angular Scissors		Safety Scissors	
78B-SC115		78B-SC116		78B-SC117 - 78B-SC119		78B-SC118 - 78B-SC120		78B-SC119S - 78B-SC120S	
78B-SC115	Str. 4 1/2"	78B-SC116	Cvd. 4 1/2"	78B-SC117	Str. 3 1/2"	78B-SC118	Cvd. 3 1/2"	78B-SC119S	Str. 9cm
				78B-SC119	Str. 4 1/2"	78B-SC120	Cvd. 4 1/2"	78B-SC120S	Cvd. 9cm



Super Cut Goldman-Fox Scissors		Super Cut Stevens Tenotomy Scissors		Super Cut Stevens Tenotomy Scissors		Super Cut Angulated Scissors	
78B-SC121 - 78B-SC122		78B-SC123 - 78B-SC124		78B-SC125 - 78B-SC126		78B-SC127	
78B-SC121	Str. 3 1/2"	78B-SC123	Str. 3 1/2"	78B-SC125	Str. 4 1/2"	78B-SC127	4 1/2"
78B-SC122	Cvd. 3 1/2"	78B-SC124	Cvd. 3 1/2"	78B-SC126	Cvd. 4 1/2"		Anguled



Iodine Cup

79-1920 06 oz. 3 7/16" x 2"
79-1921 14 oz. 4 3/8" x 2 5/8"



Mixing / Solution Bowl

79-1922 7/8qt. 6 5/8" x 2 1/2"
79-1923 1 5/8qt. 8 1/8" x 3"
79-1924 3"



Medicine Cup

79-1925 20 z. 2 1/8" x 2"



Mayo Tray

79-1926 13 3/4" x 9 3/4" x 3/4"
79-1927 21 1/4" x 16 1/4" x 7/8"



Instrument Tray

79-1928 8 7/8" x 5" x 2"



Sterilization Tray

79-1929 6 Oz. 20 3/4" x 6 3/8" x 4"
79-1930 9 Oz. 20 3/4" x 6 3/4" x 6"



Emesis Basin

79-1931 10 Oz. 6 5/8" x 3 1/2" x 1 1/2"
79-1932 12 Oz. 8 1/8" x 3 5/8" x 1 5/8"
79-1933 16 Oz. 9 7/8" x 4 1/2" x 2 1/8"

Kidney Tray

80-1968 12.00"	80-1972 9.00"
80-1969 11.00"	80-1973 8.00"
80-1970 10.00"	80-1974 7.00"
80-1971 9.50"	80-1975 6.00"

Bowel

80-1976 12.00"
80-1977 10.00"
80-1978 9.00"
80-1979 8.00"
80-1980 6.00"
80-1981 5.00"
80-1982 4.00"
80-1983 3.00"
80-1984 2.50"

Spitt Pan

80-1985

Sprit Mug

80-1986 2 x 4

Cotton Dispenser

80-1987 3 x 2

Forcep Jar

80-1988 8x8
80-1989 7x7
80-1990 6x6
80-1991 5x5
80-1992 4x4
80-1993 3x3

Sterilizing Drums

80-1994 15.5" x 8.00"
80-1995 15.5" x 6.00"
80-1996 13.5" x 13.5"
80-1997 13.5" x 9.5"
80-1998 9.5" x 9.5"
80-1999 9.5" x 6.0"
80-2000 7.5" x 5.5"

Bed Pan Gool

80-2001



Instruments Table
82-2014



Stand
82-2015



Bowl's Stand
82-2016



Mayo Table
82-2017

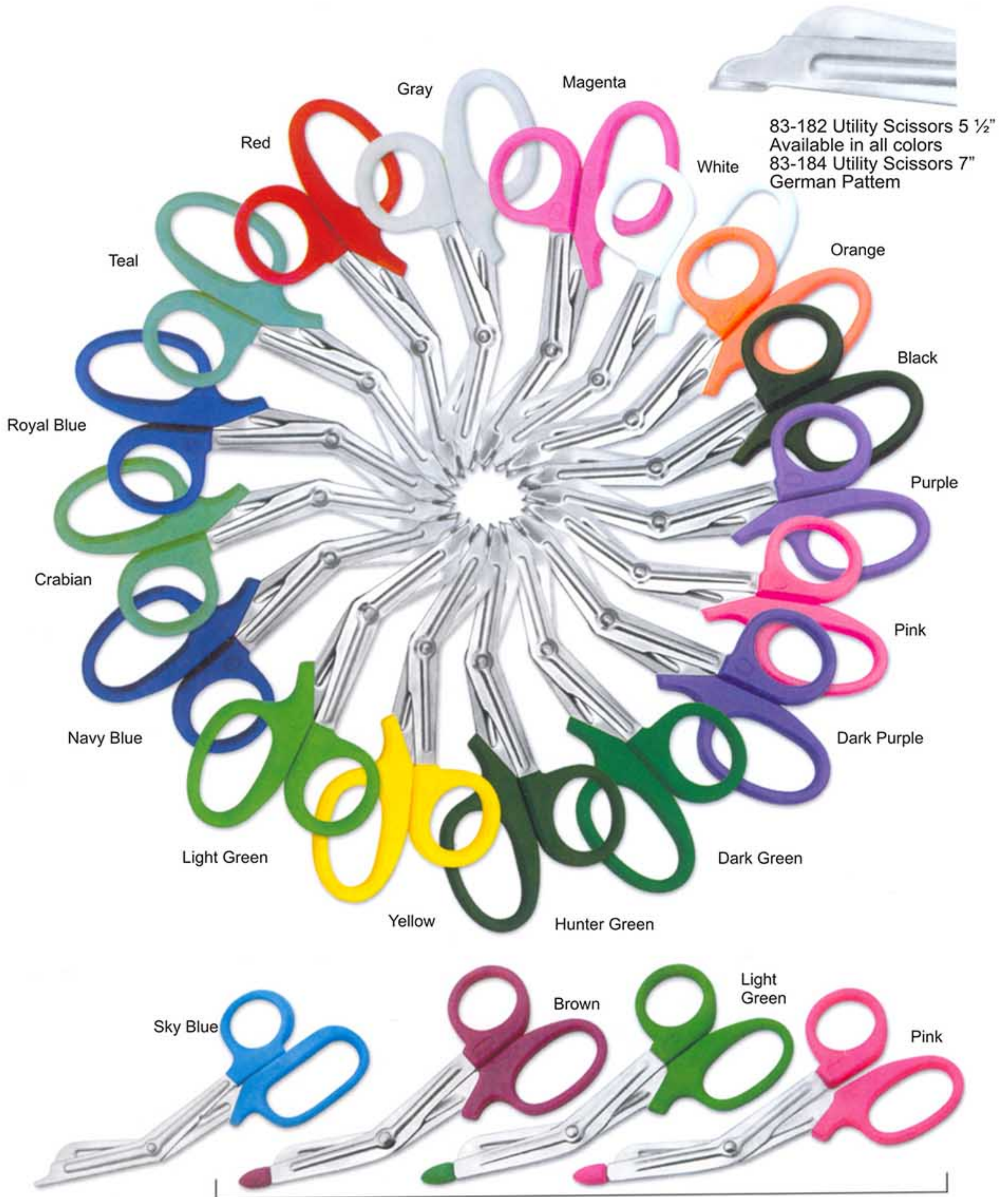

83-182 Utility Scissors 5 1/2"
Available in all colors
83-184 Utility Scissors 7"
German Pattern

83-183
Utility Scissor 7" U.S Pattern

83-182 Utility Scissor 5 1/2"
83-182 Utility Scissor 5 1/2" W / Plastic Probe. Available in all colors



A TRADITION OF QUALITY A PROMISE OF VALUE.

PAKISTAN OFFICE:

Adress: Wakeelan wali kotli new, miana pura
street#19 sialkot, Pakistan

Phone: 0523556535

Mobile: 923016191704

923446346394

Email: info@zubairmedical.com

sales@zubairmedical.com

zubairmedical@gmail.com

ECUADOR OFFICE:

M.Mkhan

Adress: El recreo qito, ecuador

Phone: 00593-25126443

00593-22682637

Mobile: 0995700007

0984370077

Email: m.mkhan@zubairmedical.com

Website: www.zubairmedical.com